

**SCHLETTER**

WE SUPPORT SOLAR.

# FLUSH MOUNT PROLINE

## INSTALLATION MANUAL

**V3.0**

LAST REVISED ON 15/05/2025

**WE  
SUPPORT  
SOLAR.**



## TABLE OF CONTENTS

|   |    |
|---|----|
| 1.0 Introduction .....  | 2  |
| 1.1 Short Description of the system.....  | 2  |
| 1.2 Scope of the Installation Manual.....   | 2  |
| 1.3 Appropriate Use/Warnings.....   | 2  |
| 1.4 Safety Instructions .....   | 3  |
| 2.0 System Overview .....   | 4  |
| 2.1 System Setup .....  | 4  |
| 2.2 Components Details .....  | 6  |
| 3.0 Installation Tools.....   | 10 |
| 4.0 Mounting Instructions .....   | 11 |
| 4.1 Mount Fasteners .....   | 11 |
| 4.1.1 Roof Hooks – Tile Roofs.....  | 11 |
| 4.1.2 Rapid <sup>2+</sup> Pro SML/Rapid Pro L – Trapezoidal and Corrugated Roofs..... | 13 |
| 4.1.3 Standing Seam Clamp – Standing Seam and Kliplok Roofs .....                     | 14 |
| 4.1.4 Direct to Sheet Fasteners.....  | 16 |
| 4.2 Rail Installation .....   | 18 |
| 4.2.1 Choice of rail .....  | 18 |
| 4.2.2 Add Rail Splice.....  | 18 |
| 4.2.3 Add Rail to Fastener .....  | 20 |
| 4.3 Module Mounting .....   | 21 |
| 4.3.1 Position Modules .....  | 21 |
| 4.3.2 Secure Modules.....   | 22 |
| 4.4 Accessories .....   | 23 |
| 4.4.1 Micro/Optimiser Kit Proline.....  | 23 |
| 4.4.2 Earthing Shims.....   | 23 |
| 4.4.3 Earthing Lug .....  | 23 |
| 4.4.4 Cable Clip Pro.....   | 24 |
| 4.6 Maintenance .....   | 26 |

## 1.0 Introduction

### 1.1 Short Description of the system

Schletter Australia offers a wide array of solutions for flush mount photovoltaic (PV) applications suitable for nearly any environmental condition. The solar mounting systems are designed for strength and ease of installation using high quality products to meet or exceed applicable local and international standards.

The system consists of fasteners securing Proline rails which support PV modules. The pre-assembled components, slide in rail joiners without the use of screws and click in module clamps accounts for the industry leading installation times and ease of installation.

The components are made from Aluminium and High-Grade Steel allowing durability in adverse site conditions. The system comes with a 25-year warranty that is compliant with Australian Standards: AS/NZS 1170.2:2021 for wind actions, AS/NZS 1170.1:2002 (R2016) for imposed loadings, and AS/NZS 1170.0:2002 for general principles.

### 1.2 Scope of the Installation Manual

The manual aims to provide information on safety warnings, mounting system setup and components for installation of PV modules in pitched metal roofs.

Section 1 and 2 focuses on introduction and an overall overview of the mounting system. Section 3 and 4 focuses on installation instructions on the appropriate methods for assembling the mounting system.

Please refer to the installation manual and bill of materials carefully before commencing any installation or maintenance work. All necessary information regarding installation and maintenance should be provided. For further questions, please contact Schletter Australia.

The content of this manual should be followed to comply with product warranty.

### 1.3 Appropriate Use/Warnings

The mounting system acts as a support structure for the installation of photovoltaic modules. Any other and/or additional use or incorrect assembly (for example: use of third-party components) or non-observance of tolerance specifications are considered as improper use and exclude any liability of the manufacturer. Any use under conditions other than those assumed in the planning is also considered as improper use and leads to the loss of any liability claims against the manufacturer.

This applies if the system is used under other load, climatic and/or corrosion conditions than originally assumed. Schletter Australia is in no case responsible for damages to the product itself or consequential damages caused by the product which are the result of an inappropriate handling of the product.

Schletter Australia is not responsible for outages or faults resulting from modifications made by the customer or other individuals. There is no entitlement to the availability of previous versions or to the re-fitting of delivered components to the current series status.

## 1.4 Safety Instructions

Read and understand these safety instructions carefully before starting the assembly and keep them safely at hand. Comply with all regional and national valid standards, building regulations and accident prevention regulations.



Break hazard! PV modules may be damaged if stepped on.



Planning, installation and commissioning of the solar power system must only be performed by qualified technical personnel. Improper execution can result in damage to the system and endanger individuals.



Electrical current hazard! Installation and maintenance of the PV modules must only be performed by qualified technical personnel. Observe the safety instructions issued by the PV module manufacturer!



Ensure all personnel are trained in proper grounding techniques and the use of earthing lugs.



Falling hazard! Working on the roof as well as ascending and descending poses a risk of falling. It is vital to observe accident prevention regulations and use appropriate fall protection equipment. PV mounting systems are not suitable as climbing aids or fall protection.



Injury hazard! Falling objects pose a risk of injury to people. Prior to installation, set up barriers in the hazard area to warn people nearby.



It is the obligation of the operator to ensure that all parts of the mounting instructions are kept within easy reach on the PV-plant for the fitters at any time.



As personnel, only persons who can be expected to carry out their work reliably can be admitted. Persons whose responsiveness is affected, e.g., by narcotics, alcohol, or medication, are NOT permitted.

## 2.0 System Overview

### 2.1 System Setup

An overview of the roof-top parallel systems as shown in the figure below, subject to changes based on project-specific requirements.

#### 2.1.1 Non-Penetrative Flush System with Seam Clamps

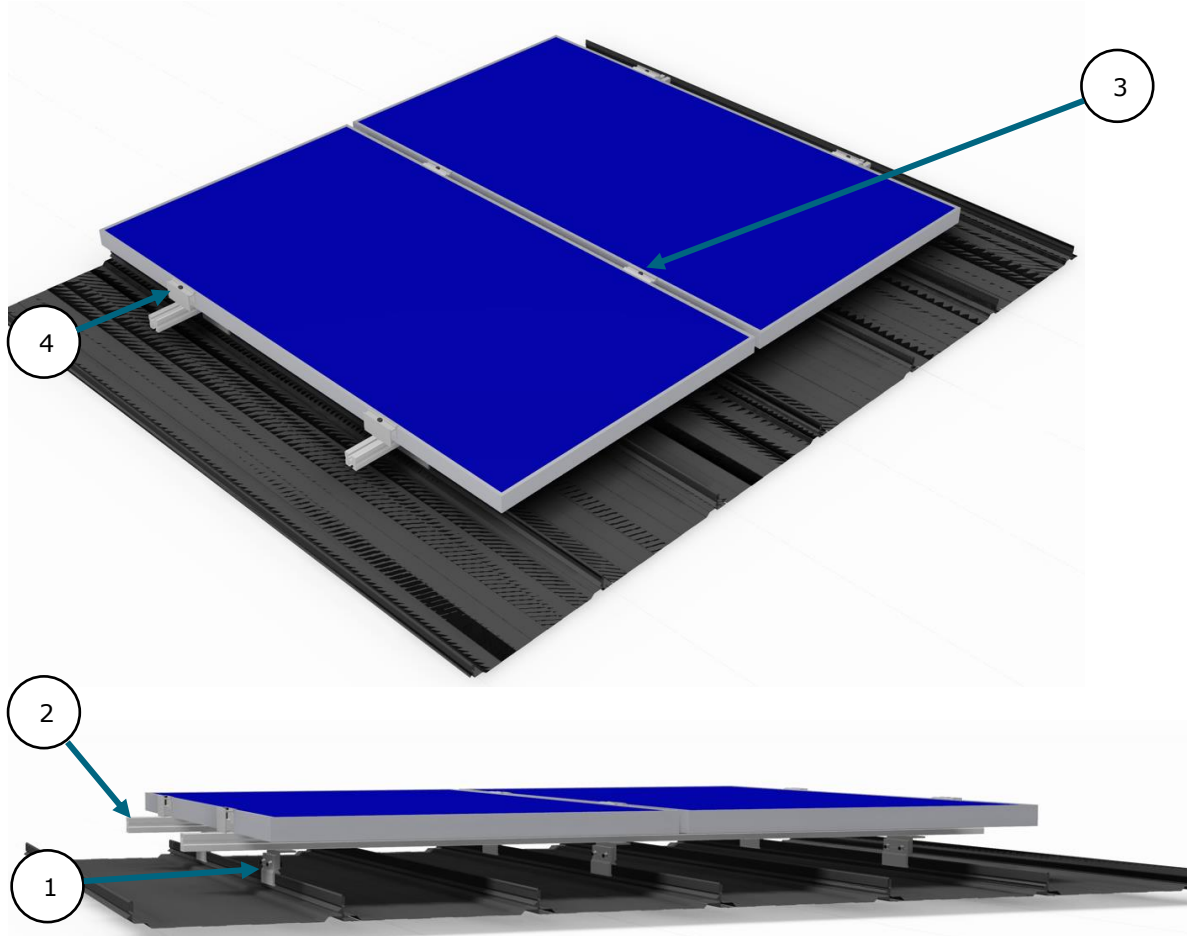

#### 2.1.2 Penetrative Flush System (Substructure) with Rapid2+ Pro SML/Rapid Pro L:

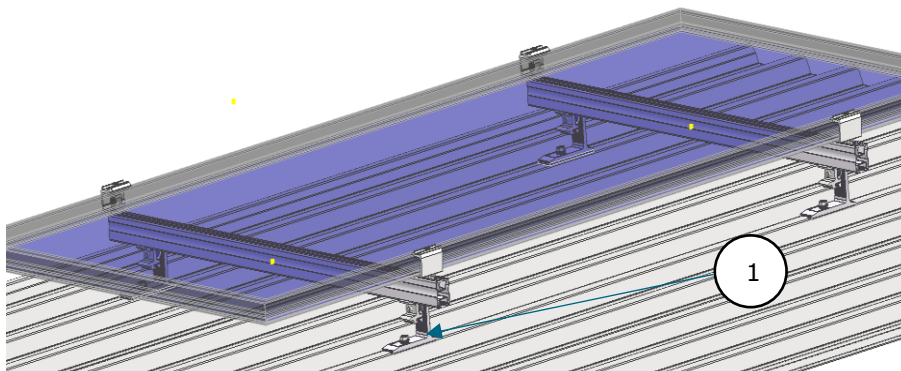

### 2.1.3 Penetrative Flush System (Roofing Sheet) with SingleFix:

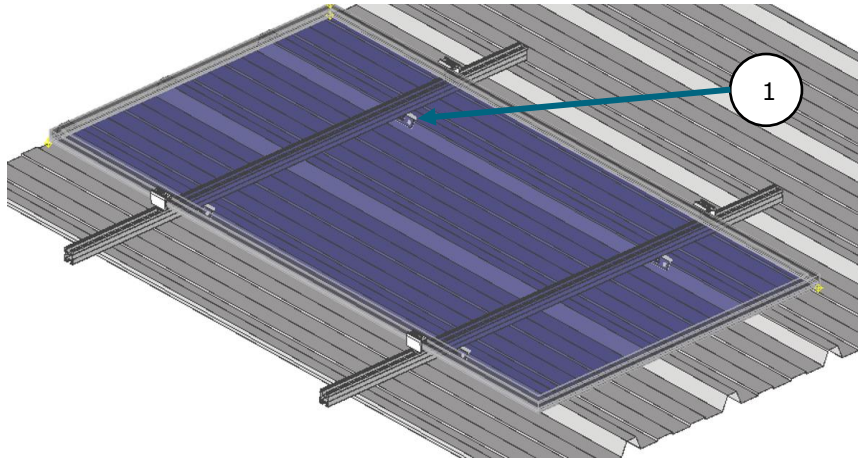







#### Key Components

- 1 Seam Clamps/Rapid 2+  
Pro SML/ Rapid Pro  
L/SingleFix Fasteners
- 2 PRO Line Rails
- 3 Middle Clamps
- 4 End Clamps

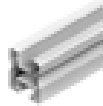
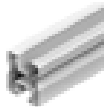
#### Accessories

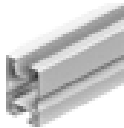
- Rail Connector
- Rail Caps
- Cable Clips
- Earth Lugs

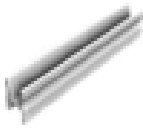
**2.2 Components Details**

| ITEM CODE    | ITEM DESCRIPTION            | IMAGE   |            |
|--------------|-----------------------------|---|------------|
| 120020-04400 | Rail Pro35 4400mm           |    | RAILS      |
| 120020-04700 | Rail Pro35 4700mm           |     |            |
| 120020-94400 | Rail Pro35 4400mm - Black   |     |            |
| 120020-94700 | Rail Pro35 4700mm - Black   |    |            |
| 120021-04400 | Rail Pro50 4400mm           |   |            |
| 120021-04700 | Rail Pro50 4700mm           |   |            |
| 129200-000   | Rail Joiner Proline         |   | JOINERS    |
| 100001-020   | Roof Hook Universal Proline |   | ROOF HOOKS |
| 108000-000   | Roof Hook Standard Proline  |  |            |

119026-102

Rapid2+ Pro SML



119026-902

Rapid2+ Pro SML Black



119026-123-0

Rapid Pro L

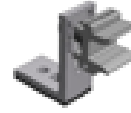

119033-006

Universal Adapter



129063-010

Cross Connector



111013-204

Corrugated EMU Proline

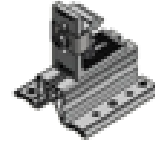

113002-226

KingFix EMU Proline



113002-223

TrimFix EMU Proline

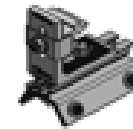

860000-50071

SingleFix-HU preassembled with RapidPro L



112012-117

KlipLok Classic EMU



112012-127

KlipLok Hi Strength EMU



FASTENERS - DIRECT TO PURLIN

FASTENERS - DIRECT TO SHEET

KLIPOK CLAMPS



---

131021-001 Mid Clamp 30-47mm Proline



---

131021-000 End Clamp 30-47mm Proline



---

131021-901 Mid Clamp 30-47mm Proline Black











---

131021-900 End Clamp 30-47mm Proline Black

---



MODULE CLAMPS

|             |                               |   |
|-------------|-------------------------------|---|
| 900000-080  | Universal Screw, Purlin 80mm  |    |
| 900000-065  | Universal Screw, Purlin 65mm  |    |
| 900000-360  | Screw, Direct to Sheet        |    |
| 129065-009  | Module Cable Clip             |    |
| 129065-100  | Cable Clip Pro                |    |
| 129065-101  | Cable Clip Pro - Black        |  |
| 129200-010  | Plastic End Cap Proline       |   |
| 129200-910  | Plastic End Cap Proline Black |   |
| 135003-002P | Earthing Clamp Proline        |  |
| 135004-002P | Earthing Shim Proline         |  |
| 149120-004P | Micro/Optimiser Kit Proline   |  |

### 3.0 Installation Tools



**Tape Measure**



**Chalk Line**



**Marker**



**Pliers**



**Angle Grinder**



**Carpenter's Square**



**Rubber Mallet**



**Torque Wrench**



**Wrench**



**Rechargeable Power Drill**



**Torx® bit (TX 40)**

## 4.0 Mounting Instructions

### 4.1 Mount Fasteners

#### 4.1.1 Roof Hooks – Tile Roofs

##### Choice of Roof Hook

The choice of roof hook proline generally depends on the height and length of the horizontal arm of the bracket from the rafter fixing point. Proline roof hook ranges as follows:

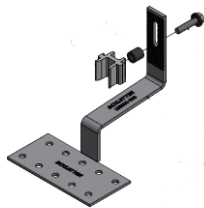

Standard Roof Hook Proline



Universal Roof Hook Proline

##### Position Roof Hook

- I. Select the mounting position along the existing rafters. Remove the roof tile.

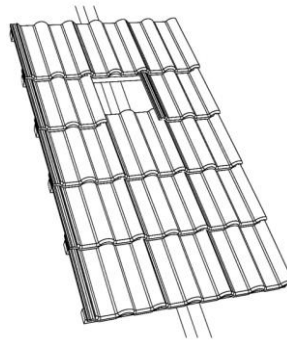

- II. Grind the bottom tile, if necessary, to remove any raised edges, that allow the roof hook to be correctly oriented maintaining a minimum distance between hook and bottom tile. Use an angle grinder with a diamond wheel for this.

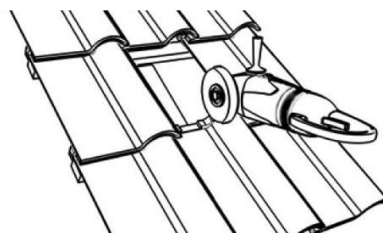

Only remove the raised edge to the extent that the minimum distance between hook and bottom tile is maintained. This is recommended to be 5mm to account for hook elasticity under load conditions.

### Fix Roof Hook to Substructure

- I. Screw on the base plate of the roof hooks using 2 of 6.2mm x 80mm, with minimum 36mm embedment into the wooden rafters. The base plate should have one screw in the upper row of holes and another in the bottom.



When ordering the roof hook, make sure the height of the horizontal arm of the bracket has been chosen correctly in relation to the batten height and tile thickness. This is to ensure the minimum distance of 5mm mentioned earlier is achieved.

If the necessary height cannot be reached, use a spacer. The height packed by the spacer is limited by the length of screws thread available after 36mm minimum embedment into the rafters.

### Cover Tiles

- I. Turn over the removed tile. Use an angle grinder with a diamond wheel to grind the raised edge section which is in line with the roof hook arm. Do not grind any deeper.
- II. Cover the tiles. Tiles should ultimately lie down as their natural ingress, to prevent any leakage of rainwater into the roof structure.

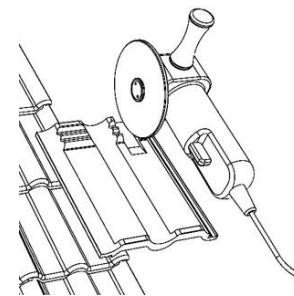

**4.1.2 Rapid<sup>2+</sup> Pro SML/Rapid Pro L – Trapezoidal and Corrugated Roofs**

- I. The Rapid<sup>2+</sup> Pro SML/Rapid Pro L fasteners are positioned on the roof ridges, using string lines for alignment.



*Fig 4.1.2A: Rapid<sup>2+</sup> Pro SMLs aligned on top of roof*

- II. Fix the fastener to the roof purlin via the supplied self-drilling universal screws, 6.2mm x 80mm. Ensure that the screw drilling line of axis is perpendicular to the roofing sheet.

The universal screw works with both timber and steel substructures if the screw embedment requirements are met:

| Substructure     | Embedment (mm)  |
|------------------|---|
| F7 Pine Softwood | 36mm  |
| 1.5 BMT Steel    | Complete Penetration<br>- For steel purlins > 1.9mm, pre-drilled hole of 4.5mm in diameter is recommended |

The fasteners must be securely connected to the substructure without deforming the roof ridge.

The tightening torque must be limited (15Nm) to prevent this deformation and to ensure thermal expansion is not impeded.

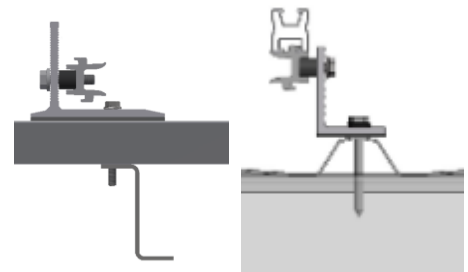

*Fig 4.1.2B: Rapid<sup>2+</sup> Pro SML and Rapid Pro L being attached to purlin using universal screw*

**Schletter Advantage**

- The fasteners can be used for both metal and timber substructures.
- The height adjustable multi-adaptor allows for rail adjustment across uneven roofs. It also helps to achieve good clearance between panels and roof sheets for heat dissipation.
- The UV resistant EPDM rubber inlay on the bottom of the fastener guarantees water tightness.

### 4.1.3 Standing Seam Clamp – Standing Seam and Kliplok Roofs

Schletter provides non penetrative fasteners for concealed roofs. The choice of fasteners is based on the correct identification of the Kliplok roofing sheet at site.

| Fastener               | Roof Sheet                     | Fixing Method  | Images     |
|------------------------|--------------------------------|--|------------|
| Kliplok Classic EMU    | Lysaght KlipLok Classic 700    | Non-Penetrative:<br>Clamping to<br>roofing sheet rib | Fig 4.1.3A |
|                        | Lysaght KlipLok Classic 406    |  |            |
| Kliplok HiStrength EMU | Lysaght KlipLok HiStrength 700 |  | Fig 4.1.3B |
|                        | Lysaght KlipLok HiStrength 406 |  |            |
|                        | Stramit Speed Deck Ultra       |  |            |
|                        | Metlock 700                    |  |            |
|                        | Stratco Topdek 700             |  |            |

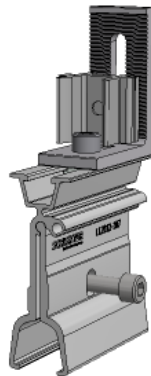

Figure 4.1.3A: Kliplok Classic EMU

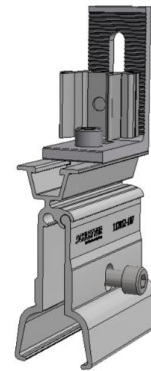

Figure 4.1.3B: Kliplok High Strength EMU

The standing seam clamp has dual slots that enable the seam clamp to clamp to different-width roofing sheets. Figure 4.1.3C shows the seam clamp configured for Lysaght Classic and High Strength profiles.

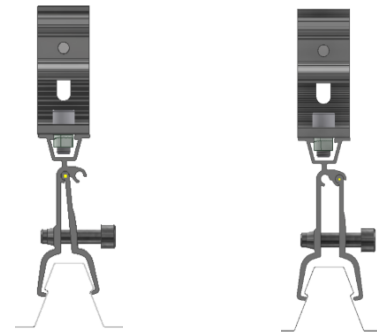

Figure 4.1.3C: Seam Clamp using outer slot Kliplok High Strength (right image) and inner slot for Kliplok Classic (left image)

#### Installing Seam Clamp on the roofing sheet

- I. Once the appropriate seam clamp is selected, position the seam clamps on the roof as per the rail installation plan.
- II. Keep the bolt loose so the Kliplok clamp can easily pass over the roofing sheet rib and firmly sit over the crest.
- III. Secure the seam clamps to the roof by tightening the single M8 bolt (14Nm), as shown in Fig 4.1.3D. The single bolt tightening combined with

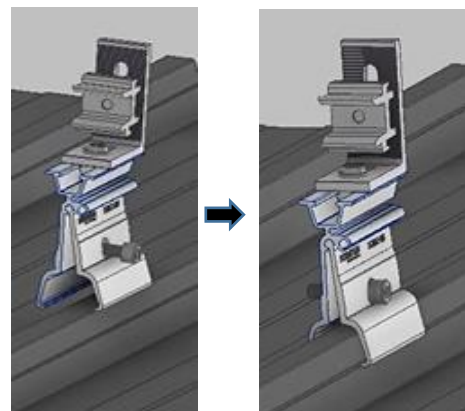

Figure 4.1.3D: Seam clamp positioned and secured on the roofing sheet.

pre-assembled EMU adaptor makes the system fast and easy to install.

Please limit tightening torque to recommended settings to avoid deformation of the standing seams and to ensure that thermal expansion of the metal sheets is not impeded.

**!** Please follow the roofing sheet manufacturer guidelines on fixing fasteners on lapjoints. Generally, this is not a recommended practise.

IV. The preassembled L bracket on top of the seam clamp can be oriented for landscape or portrait orientation as shown in Figure 4.1.3E.

V. Once the orientation is finalised, tighten and secure the M8 bolt (14 Nm) between the clamp and the preassembled L bracket.

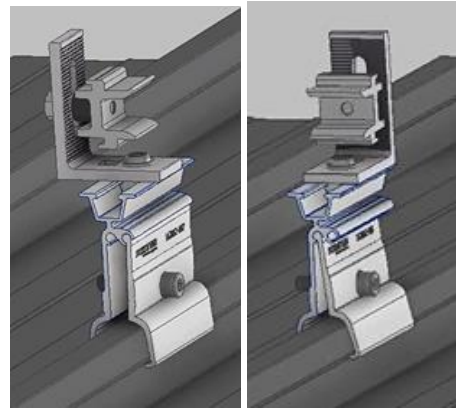

Figure 4.1.3E: Landscape (left image) and portrait (right image) orientation of fasteners



**4.1.4 Direct to Sheet Fasteners**

Schletter provides various fastener options for installing direct to roofing sheets. This method involves fixing the fastener to the roofing sheet instead of purlins with self-drilling screws. The choice of fastener depends on the roof sheet:

| Fastener       | Roof Sheet           | Fixing Method   | Images     |
|----------------|----------------------|-----------------|------------|
| TrimFix        | Trimdek              | Direct to Sheet | Fig 4.1.4A |
| KingFix        | Kingspan             |                 | Fig 4.1.4B |
| SingleFix      | Any Trapezoidal Roof |                 | Fig 4.1.4C |
| Corrugated EMU | Corrugated           |                 | Fig 4.1.4D |

The installation process involves firmly placing KingFix/TrimFix/SingleFix and Corrugated EMU brackets on top of the roofing sheet ribs as per the installation plan. The fasteners are secured with the help of the supplied 4 self-drilling universal screws, 6.2mm x 25mm (2 on either side of the roof rib) with tightening torque of 6Nm, as shown in Figures 4.1.4A, 4.1.4B, 4.1.4C and 4.1.4D respectively.

- I. The installation process involves firmly placing KingFix/TrimFix/SingleFix and Corrugated EMU brackets on top of the roofing sheet ribs as per the installation plan.
- II. The fasteners are secured with the help of the supplied 4 self-drilling universal screws, 6.2mm x 25mm (2 on either side of the roof rib) with tightening torque of 6Nm, as shown in Figures 4.1.4A, 4.1.4B, 4.1.4C and 4.1.4D respectively.

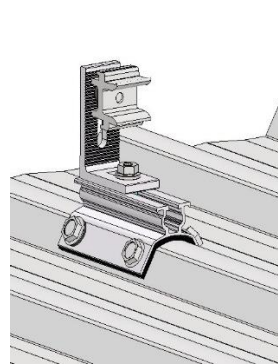

Fig 4.1.4A: TrimFix EMU

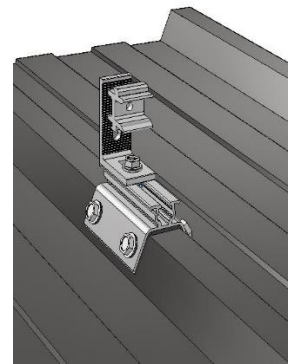

Fig 4.1.4B: KingFix EMU

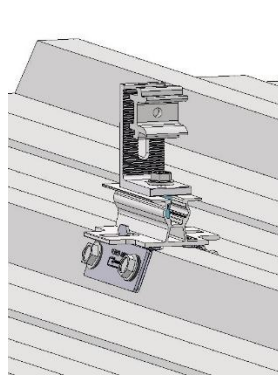

Fig 4.1.4C: SingleFix EMU

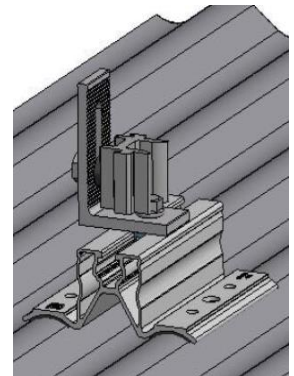

Fig 4.1.4D: Corrugated EMU

- III. The fasteners (KingFix/TrimFix/SingleFix and Corrugated EMU) come pre-assembled L bracket which enables the rail to run both parallel and perpendicular to roofing sheet ribs for landscape and portrait panel orientations (Figure 4.1.4E).
- IV. Once the orientation is finalised, tighten and secure the M8 bolt (14 Nm) between the clamp and the preassembled L bracket.

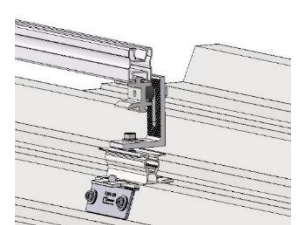
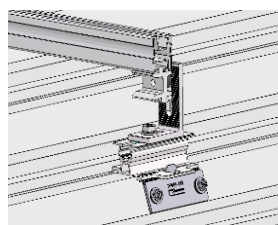
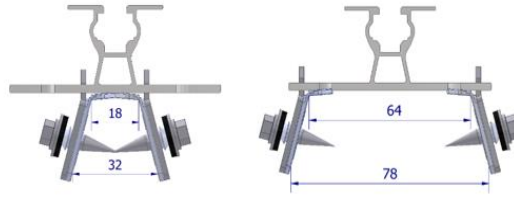

Figure 4.1.4E: SingleFix Fastener in Landscape (left) and Portrait (right) orientations

The SingleFix bracket arms are adjustable to different rib widths of roofing sheets, making them ready for application in unknown trapezoidal roofing sheets. The dimensions of the minimum and maximum opening of the arms of the SingleFix brackets are shown in Figure 4.1.4E.



*Fig 4.1.4E Single Fix fastener max and min opening*

- ⚠ With fixing fasteners to roofing sheets with self-drilling screws, Schletter urges installers to take extra precautions against waterproofing the installation against leaks beyond conventional rubber.
- ⚠ Please note it is imperative to use a tool with no ability for percussion, hammer, rattle gun or similar methods of fastening when securing these screws for direct to sheet applications.

## 4.2 Rail Installation

### 4.2.1 Choice of rail

The Proline rails come in standard sizes of 4400mm and 4700mm.

Based on required spans and site conditions, the rails come in the following dimensions:

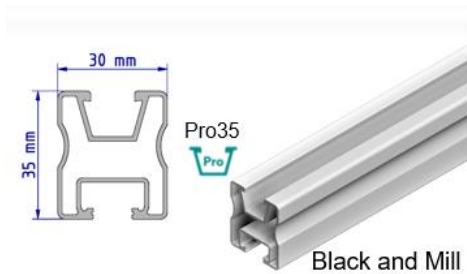

**Pro35**

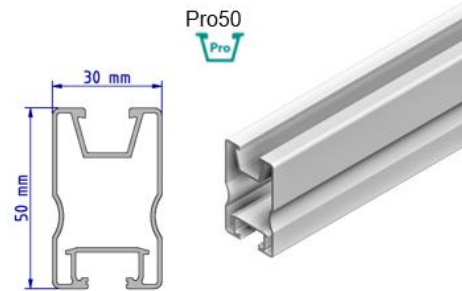

**Pro50**

### 4.2.2 Add Rail Splice

- I. To increase the array length, rails can be spliced together using rail joiners [Fig 4.2.1A].
- II. Insert half of internal splice into first rail, push until it reaches midpoint where the stop tab is located under the splice [Fig 4.2.2B].
- III. Add second rail to opposite end until it fully reaches the middle stop plate. This should lock both rails together forming a longer array [Fig 4.2.2C].

No screws are required, saving installation time.

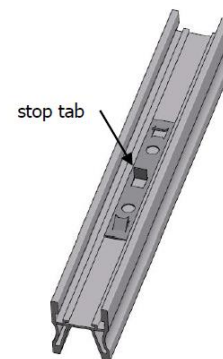

Fig 4.2.1A: Rail Joiner

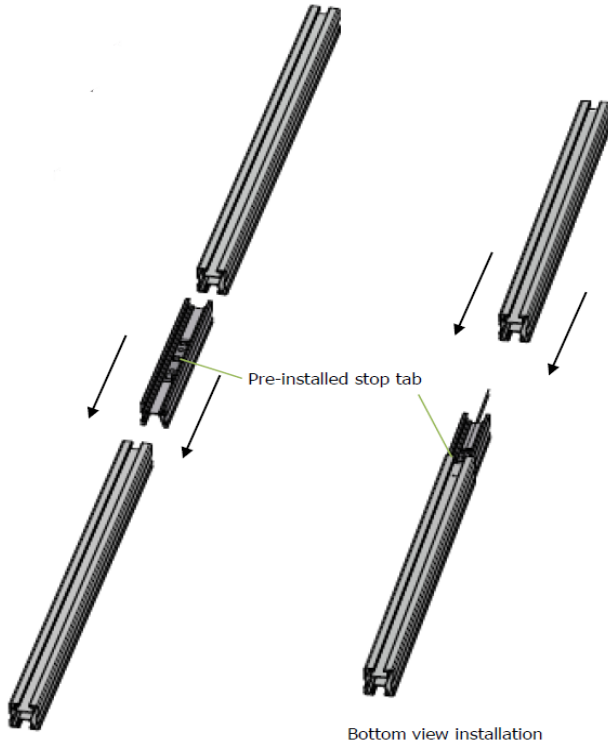
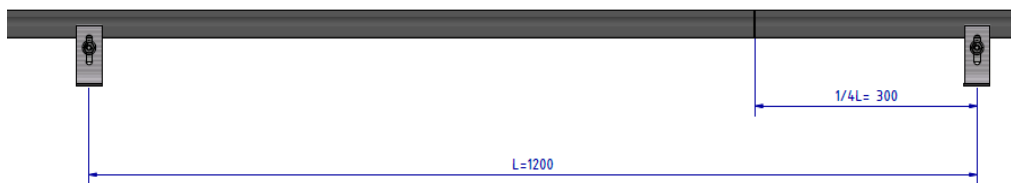

Fig 4.2.2B: Joiner connecting Proline rails

Fig 4.2.2C: Rails secured together via Proline joiner

- ⚠ It is recommended to limit array lengths to a maximum of 20m, due to thermal expansion limitations, for fixing to substructure. However, this should be limited to 11m for fixing in roofing sheets (for example: Kliplok clamps).
- ⚠ The rail joiners are for single use application only.
- ⚠ Rail overhang should be limited to 400mm or 40% of the fastener spacing, whichever is lower.
- ⚠ Rail Joiner should not be installed on overhangs. It can be installed anywhere between the two fasteners, preferably  $1/4L$  distance away from the fastener, where,  $L$  is the fastener span:



- ⚠ Schletter recommends the rail joiner to be installed not within 30mm of the fastener.

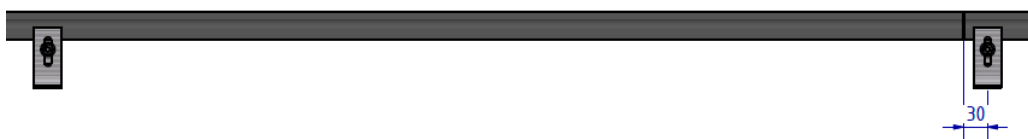

### 4.2.3 Add Rail to Fastener

- I. Position the bottom (rectangular channel) of Proline rails on top of the multi adaptor tab fit for Proline rails, as shows in Fig 4.2.3A.
- II. Push down the length of rail, spliced together, on the multi adaptor tab, so that the tab locks into the bottom channel of the rail.
- III. Secure by tightening the bolt on the fasteners using recommended torques (14Nm) once the rail has been positioned to rest correctly on top of the fastener, as shown in Fig 4.2.3B.

#### **Notes:**

Please note that, the multi adaptor tab should be oriented as shown in Fig 4.2.3A i.e. the tab that is closer to the L foot upright, is fit for Proline rails.

The multi adaptor comes pre-assembled with Rapid<sup>2+</sup> Pro SML, roof hooks, seam clamps and direct to sheet fasteners. This means one fastening method can be used across all the flush mount fasteners.

If necessary, adjust the rails to the desired height to compensate for roof unevenness before tightening the bolt.



Fig 4.2.3A: Multi Adaptor fixing rail to fastener



Fig 4.2.3B: Rail attachment to fasteners (substructure fixing)

## 4.3 Module Mounting

### 4.3.1 Position Modules

- I. Position end clamps on rail approximately 50 mm from end of rail, for anti-slip consideration.

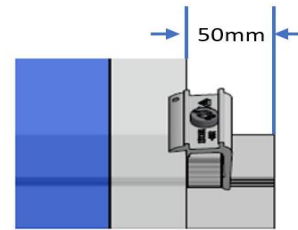

Fig 4.3.1A: Positioning end clamp

- II. Position first module and secure using pre-positioned end clamps [Fig 4.3.1B].

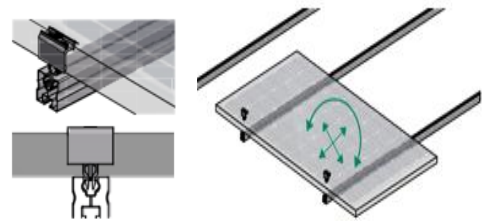

Fig 4.3.1B Positioning first module

- III. Attach middle clamps to rail on the exposed side of the first module [Fig 4.3.1C].

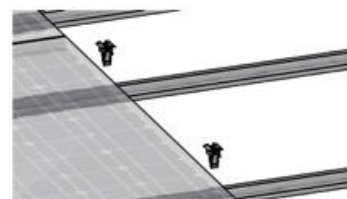

Fig 4.3.1C Positioning middle clamps

- IV. Place second module next to first module and secure using middle clamp [Fig 4.3.1D].

- V. Repeat until end of row.

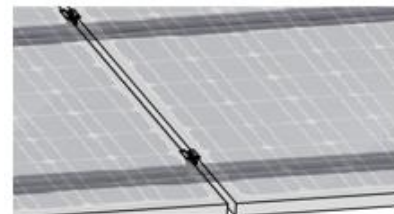

Fig 4.3.1D Positioning second module

### 4.3.2 Secure Modules

- I. Verify that the module clamp is fully engaged on the rail and 1.5 mm maximum middle clamp to module offset is aligned with the module frame [Fig 4.3.2A].
- II. Secure all clamps [middle and end] to recommended torque settings [15Nm].

When mounting modules, please observe the clamping points specified by the module manufacturers.

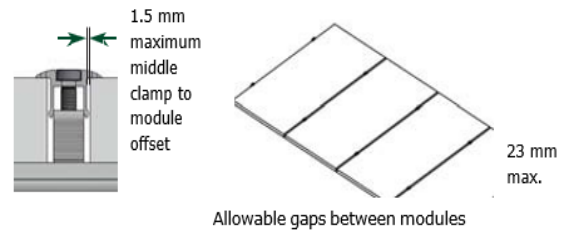

Fig 4.3.2A: Securing middle clamp and PV modules

- III. Please observe 30mm gap between module rows for better heat dissipation [Fig 4.3.2B].

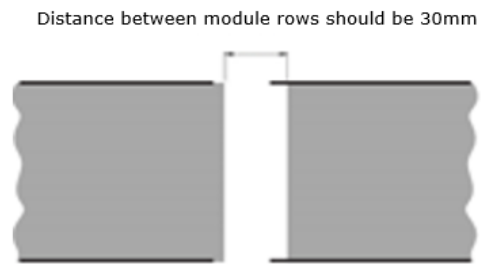
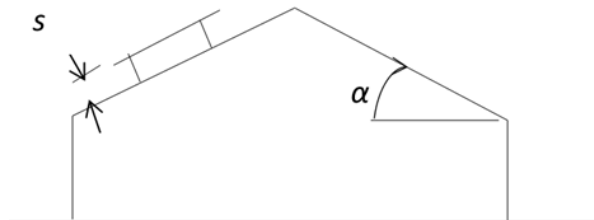

Fig 4.3.2B: Gap between PV Module rows

**!** Please maintain an exclusion zone of  $2s$ , where 's' is the distance between underside of the panel and the roof.



## 4.4 Accessories

### 4.4.1 Micro/Optimiser Kit Proline

The optimiser kits enable mounting of optimisers and micro-inverters on top of the Proline Rails.

- I. Loosely connect the bolts and washer to the mounting holes of the micro-inverter.
- II. Slide in or simply insert the hammerhead nut from above.
- III. Secure the bolt using recommended torque settings [14Nm].

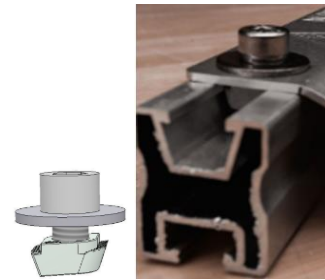

### 4.4.2 Earthing Shims

The earthing shims are recommended to achieve a lower resistance on the black anodised systems ensuring better conductivity between anodised elements of the mounting system. This is applicable for a fully black anodised system and excludes mill-finished systems (self-earthed via mid and end clamp earthing pins).

- I. Slightly lift the PV panels and insert the earthing shim and mid clamp in position.
- II. The correct alignment involves one pair of earthing shim pins under each of the two adjacent panels.
- III. Once the middle clamps are secured with the bolts properly torqued, the teeth of the earthing shims would penetrate the anodisation layers of the panel and rail to provide electrical continuity.



*Fig 4.4.2A: Earthing Shim Alignment around mid-clamp*



An appropriate level of earthing continuity can be achieved without using Earthing shims on Anodised rail. Please talk to your technical representative for training. The earthing shims ensure better conductivity and are recommended to achieve a lower resistance on the black anodised systems between anodised elements of the mounting system. This is applicable for a fully black anodised system and excludes mill-finished systems (self-earthed via mid and end clamp earthing pins).

### 4.4.3 Earthing Lug

The earthing lug can be used as a potential equalization within the mounting racks.

- I. The lug can be positioned by top entry or sliding in top of the rail [V-channel] using the hammerhead nuts.
- II. Place the earthing wires inside the lug chamber.
- III. Use a calibrated torque wrench to apply the recommended 14 Nm torque for a secure connection.
- IV. Inspect the connection to ensure the earthing wire is properly seated and there are no loose strands.





- V. The advisable positioning of the earthing lug on the rails is as follows:
- Lug distance to the edge of rail: 8-10 mm.
  - Connection (single/multi-wired): 4-50 mm<sup>2</sup>.



The earthing of the PV system can be achieved with one earthing lug per array as the entire system is bonded via integrated earthing pins on the mid and end clamps.

However, additional lugs can be provided upon request, as the final responsibility to ensure earthing at the site is upon the installers in order to maintain compliance with AS/NZS 3000.



#### 4.4.4 Cable Clip Pro

Schletter provides cable management options with the Proline rails via the rail cable clips. They come in silver and black options.

- Insert cable clip into the top of the Proline rail channel. Once pressed this should click in and be firmly attached to the side of the rail as shown in Figure 4.4.4B.
- Insert cable clip by pushing firmly into the channel, until it snaps in, as shown in Fig 4.4.4A.
- The cables are then run through the retainer and the clip holds the cables firmly in place.
- Can hold 4mm or 6mm cables.



Figure 4.4.4A: Cable Clip Pro in silver and black

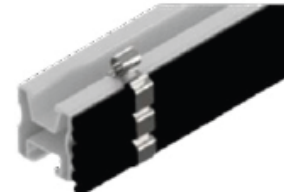

Figure 4.4.4B: Cable Clip Pro with cables running parallel to rail

#### 4.5 Torque Specifications and Tolerances

The various bolt sizes of the mounting system and their recommended torques in the mounting system is listed as follows:

| <b>Bolt Size</b>   | <b>Recommended Torques</b> |
|--|----------------------------|
| Torx Bolt for RapidPro Module Clamps   | 15 N-M                     |
| M6 and 1/4" Bolt   | 6 N-M                      |
| M8 and 5/16" Bolt  | 14 N-M                     |
| M10 and 3/8" Bolt  | 30 N-M                     |
| M12 and 1/2" Bolt  | 50 N-M                     |
| M16 and 5/8" Bolt  | 121 N-M                    |
| M20 and 3/4" Bolt  | 244 N-M                    |
| <b>Note:</b> Recommended speed for installation of self-drilling 1/4" diameter is 1200-1800 RPMS |                            |

*Table 4.5: Size of bolt and recommended torques*

For project specific system design, please refer to project specific drawings for recommended torque for each size of bolt used in the system and allowable tolerances. In the event of deviation from approved drawings, contact Schletter Australia immediately.

#### 4.6 Maintenance

In general, once correctly assembled, the roof-top systems should operate reliably with minimal maintenance. However, Schletter Australia and New Zealand recommends the following best practices and inspection guidelines for the system’s long-term durability and reliability.

- I. Regular inspection is required every 6-12 months post installation. For highly corrosive areas, this section should be more frequent at every 3-6 months to maintain optimal performance.
- II. Prior to installation, it is advisable to store products free from contamination by contact with items that may contain rust, dirt and chemicals. If contamination occurs, affected products have to be cleaned using appropriate methods such as using galvanised zinc spray on affected areas.
- III. Clean any visible contamination from soil, and other particles using freshwater via non-abrasive cloth or sponge. This is to remove any salt residue if the components are exposed to a highly corrosive environment.

Further guidelines on this can be found in:

| Standards                                     | Material  | Country     |
|---|-----------|-------------|
| Standards Association of Australia            | Aluminium | Australia   |
| Galvanizers Association of Australia (GAA)    | Steel     | Australia   |
| Galvanizers Association of New Zealand (GANZ) | Steel     | New Zealand |

- IV. Visually inspect for signs of damage, wear, corrosion, or movement. Replace any affected components immediately.



Aluminium components may undergo surface oxidation, forming a thin and hard film of Aluminium oxide which looks like powdery white or dull grey finish. This is standard ageing process for Aluminium and is beneficial for long-term durability of the product. The oxide layer acts as a barrier against atmospheric corrosion.

- V. Check torque values of fastening bolts in the structure as per recommended torques in section 4.5. The following inspection process can be followed:
  - a) At least 2% of bolted connections must be checked using a calibrated torque wrench. The torque wrench must have a display or be a click type torque wrench.
  - b) Torque wrench should be set at 50% of intended tightening torque. Check is successful if the bolt cannot be loosened.
  - c) If more than 10% of checked bolted connections are loose, a re-check has to be done. The re-check should be increased to 10% of all bolted connections.
  - d) If more than 10% of connections are still loose, all bolted connections must be checked.
  - e) Tighten all non-conforming bolts to specified torques as per section 4.5.
- VI. Check for loose wiring.
- VII. Apply anti-corrosion compound to connection points, especially in coastal high corrosivity areas.
- VIII. It is recommended to add earthing shims under mid and end clamps (panel clamping zones) during installation to ensure additional earthing continuity if the site is in highly corrosive environment.

The maintenance guidelines above apply only to the components of the mounting structure that are manufactured from Schletter. For external components, maintenance should be carried out respective to the relevant manufacturer’s guidelines.

# WE SUPPORT SOLAR.

We're always here to provide you with comprehensive, expert advice on your system planning, and to answer any questions you may have about logistics and order processing.

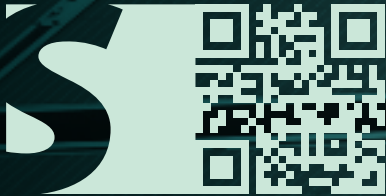

**SCHLETTER AUSTRALIA PTY LTD**  
71-73 Newton Road, Wetherill Park  
NSW 2164

[www.schletter-group.com](http://www.schletter-group.com)