

IQ Battery 5P

Quick Install Guide

MODEL
IQBATTERY-5P-1P-ROW

VERSION 2.0
APRIL 2023



140-00278-02



To install the Enphase IQ Battery 5P and the wall-mount bracket, read and follow all warnings and instructions in this guide. Safety warnings are listed at the end of this guide. These instructions are not meant to be a complete explanation of how to design and install an energy storage system. All installations must comply with national and local codes and standards. Only Enphase certified installers shall install, troubleshoot, or replace IQ Battery 5P.

The IQ Battery 5P system includes the battery cellpack with integrated IQ Microinverters and battery management system (BMS). The system requires IQ System Controller for grid-tied and backup operations. The IQ Gateway inside IQ System Controller measures PV production, IQ Battery 5P charge/discharge power and home energy consumption, and it senses when it is optimal to charge or discharge the battery so that energy is stored when it is abundant and used when it is scarce.



Table of contents

What's in the box

Tools/additional items required

Unboxing IQ Battery 5P

Section A Mounting the product

Plan a location for the IQ Batteries

Step 1: Minimum clearance

Step 2: Mounting surface

Step 3: Install the wall-mount bracket

Section B Installing IQ Battery 5P

Step 1: Prepare to install IQ Battery 5P on mounting bracket

Step 2: Prepare for field wiring

Section C Wiring

Install conduit/raceway adapter and field wiring

Section D Close and energize the system

Disassembly of IQ Battery 5P cover

Configure and activate

Operation

LED overview

Operating mode and set points LED overview

Troubleshooting

Safety

What's in the box

ID cover

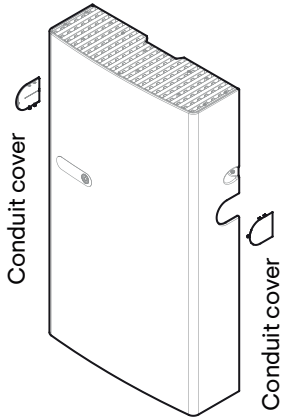

IQ Battery 5P

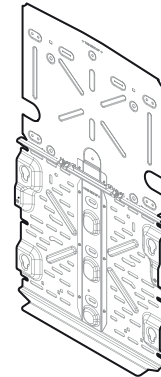
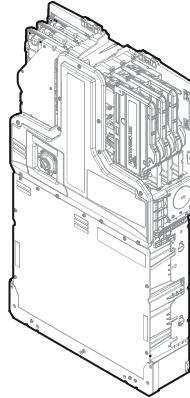

Top shield

Mounting bracket

M5 Seismic screw

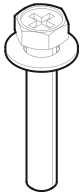

M4 Grounding screw



M5 ID Cover Grounding screw



Quick Install Guide

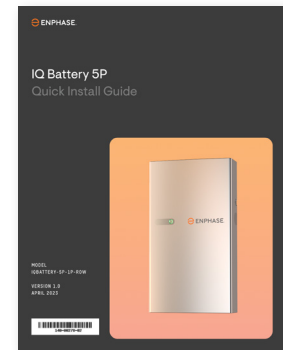

DESCRIPTION	MODEL NUMBER	QUANTITY
IQ Battery 5P	B05-T02-ROW00-1-2	1
ID cover, two conduit covers	B05-CX-0550-O	1
Mounting bracket & top shield	B05-WB-0543-O	1
M5 Seismic screw		2
M4 Grounding screw		2
M5 ID Cover Grounding screw		2
Quick Install Guide		1

Tools/additional items required

S. NO	ITEM NAME	QUANTITY		SOURCE
1	Conduit up to 32 mm (1-1/4 in) for side entry and up to 3/4 in (19 mm) for rear entry	As required		Provided by Installer
2	Conduit fittings and tools must be IP55 rated when installing outdoors	As required		Provided by Installer
3	Raceway adapter – must be IP55 rated when installing outdoors	As required		Enphase store/ provided by Installer
4	Drill	1		Provided by Installer
5	4 mm pilot bit	1		Provided by Installer
6	Screwdriver	1		Provided by Installer
7	Wrench	1		Provided by Installer
8	Socket wrench	1		Provided by Installer
9	Torque wrench	1		Provided by Installer
10	Level	1		Provided by Installer
11	Conductor stripper	1		Provided by Installer
12	Stud finder (if required)	1		Provided by Installer
13	Copper conductors - 6 mm ² to 30 mm ² (11 mm or 7/16 in strip length) (rated at 90°C) for terminals	As required		Provided by Installer
14	Control cable	As required		Provided by Installer
15	Personal protective equipment for handling lithium batteries as required by local safety standards	As required		Provided by Installer
16	Protective gloves for protection against sharp edges	As required		Provided by Installer
17	M8 lag bolts or screws to mount the bracket on wall. Slots are 9.2 mm (0.36 in) for wall mount and 11.2 mm (inclined slots) for pedestal. Check with a structural engineer and local standards for requirements	Single stud mounting (Min. 3)	Dual stud mounting (Min. 4)	Provided by Installer
18	M6 screws to fasten top shield on wall	Single stud mounting (Min. 2)	Dual stud mounting (Min. 5)	Provided by Installer
19	Washers	As required		Provided by Installer
20	IQ Battery 5P lifting handles. Includes one left side and one right side lifting handle (IQBATTERY-HNDL-5)	1		Enphase store/ provided by Installer

Tools/additional items required

NOTE: The Enphase IQ Battery 5P system requires an Internet connection through the IQ Gateway in the IQ System Controller. Failure to maintain an Internet connection may have an impact on the warranty. See enphase.com/warranty for full terms.

The IQ Battery 5P and IQ System Controller are all connected to the IQ Gateway and communicate using communication control cables. The Enphase PV system communicates to the IQ Gateway using Power Line Communication.

NOTE: The rated energy capacity of the battery is 5.0 kWh.

Install the PV system and the IQ System Controller as directed by the Enphase installation manuals.

Unboxing IQ Battery 5P

Before you unbox IQ Battery 5P, check the “Energize By” label on the shipping box to verify that the IQ Battery(ies) will be installed by the date shown. If the date has passed, contact your distributor for next steps.

1. Remove the upper packaging cover and follow the steps as shown in the following image:

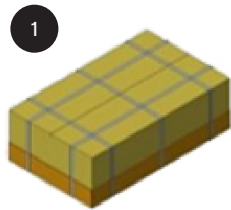

1

Remove the six plastic strips

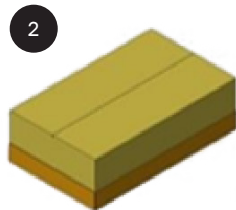

2

Remove the exterior cardboard box lid

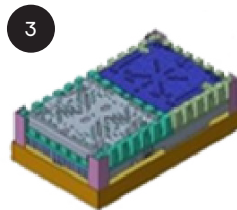

3

Remove the four corner guards

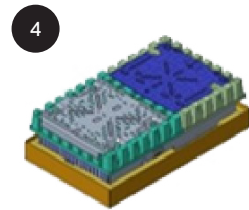

4

Remove the top shield

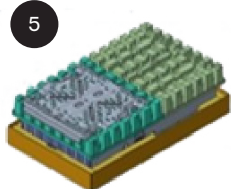

5

Remove the paper tray

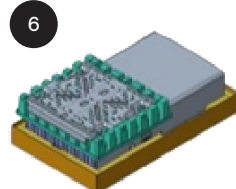

6

Remove the wall bracket

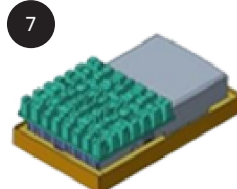

7

Remove the other paper tray to reveal the battery cover

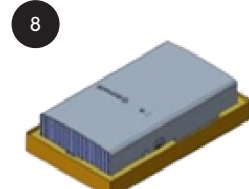

8

Remove the IQ Battery 5P cover

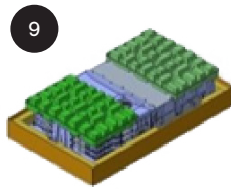

9

Remove the two paper trays

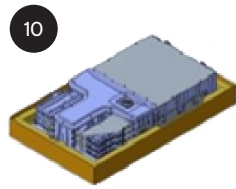

10

Remove the IQ Battery 5P using lifting handles

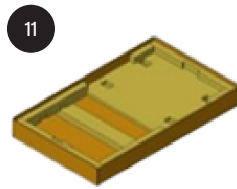

11

Recycle packaging according to local guidelines

2. Inspect the packaging and the IQ Battery(ies) for any signs of damage, such as cracks, dents, or electrolyte leaks. Do not install or use the IQ Battery(ies) if it has been dropped or damaged in any way. If damaged, contact your distributor for replacement.

 Risk of injury. Take care when lifting. The IQ Battery 5P unit is heavy (66.25 kg/146.05 lbs) and requires two people to lift it.

Section A

Mounting the product

Plan a location for the IQ Batteries



- The IQ Battery 5P housing is IP55 rated and can be installed indoors or outdoors. The terminal blocks accept copper conductors of 6 mm² to 30 mm².

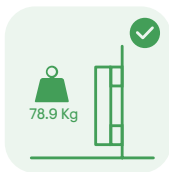

- Make sure the installed location can sustain the total weight of the IQ Batteries and mounting bracket. Total weight for IQ Battery 5P, including the IQ Battery 5P unit, cover and wall-mount bracket, is 78.9 kg (174 lbs). The wall must contain blocked studs that can bear the battery weight or can be of masonry or other suitable structure.
- Make sure there are no pipes or electrical wires where you plan to drill.

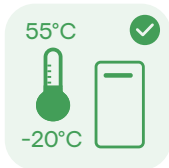

- Follow local standards (AS/NZ5139) : Choose a well-ventilated location where the ambient temperature and humidity are within -20°C to 55°C (-4°F to 131°F) and 5% to 95% relative humidity, non-condensing, out of direct sunlight. The optimum ambient temperature range for installation location is 0°C to 30°C (32°F to 86°F). Provide smoke alarms in the residence in accordance with building, fire, and installation codes.

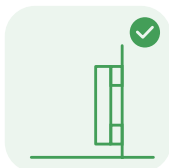

- Consider the dimensions of the IQ Batteries, easy access, height, and length of cable when selecting the location.
- Select a location where you can interconnect IQ Battery 5P to the IQ System Controller.



- This product must not be installed at altitudes above 2,000 m.
- Follow all local standards and regulations set forth by the Distributed Network Service Provider (DNSP).



- Up to four IQ Battery 5P units can be daisy chained on a single branch circuit. IQ System Controller supports up to a maximum of 80 A breaker for IQ Battery 5P connection circuit.
- The maximum conductor size for IQ Battery 5P is 30 mm² and the maximum breaker rating with this conductor size is 80 A.

Section A - Mounting the product

Step 1: Minimum clearance

The mounting instructions that follow are for the included wall-mount bracket only. If you wish to install IQ Battery 5P in a floor-mount configuration, order the pedestal accessory (B05-PM-0550-O) and refer to the floor-mount instructions that come with that product. This product must be installed with clearance at the left, right, top, bottom, and front of the product as shown in the figure.

Keep IQ Battery 5P away from falling or moving objects, including motor vehicles.

 If mounted in the path of a motor vehicle, Enphase recommends a minimum mounting height of 91 cm (36 in) above the floor.

For IQ Batteries mounted at the same level, the minimum distance between covers of two units can be up to 146 mm. Use the raceway adapter (Enphase Accessory) between units only if the distance between units is ≤ 165 mm (6.5 in).

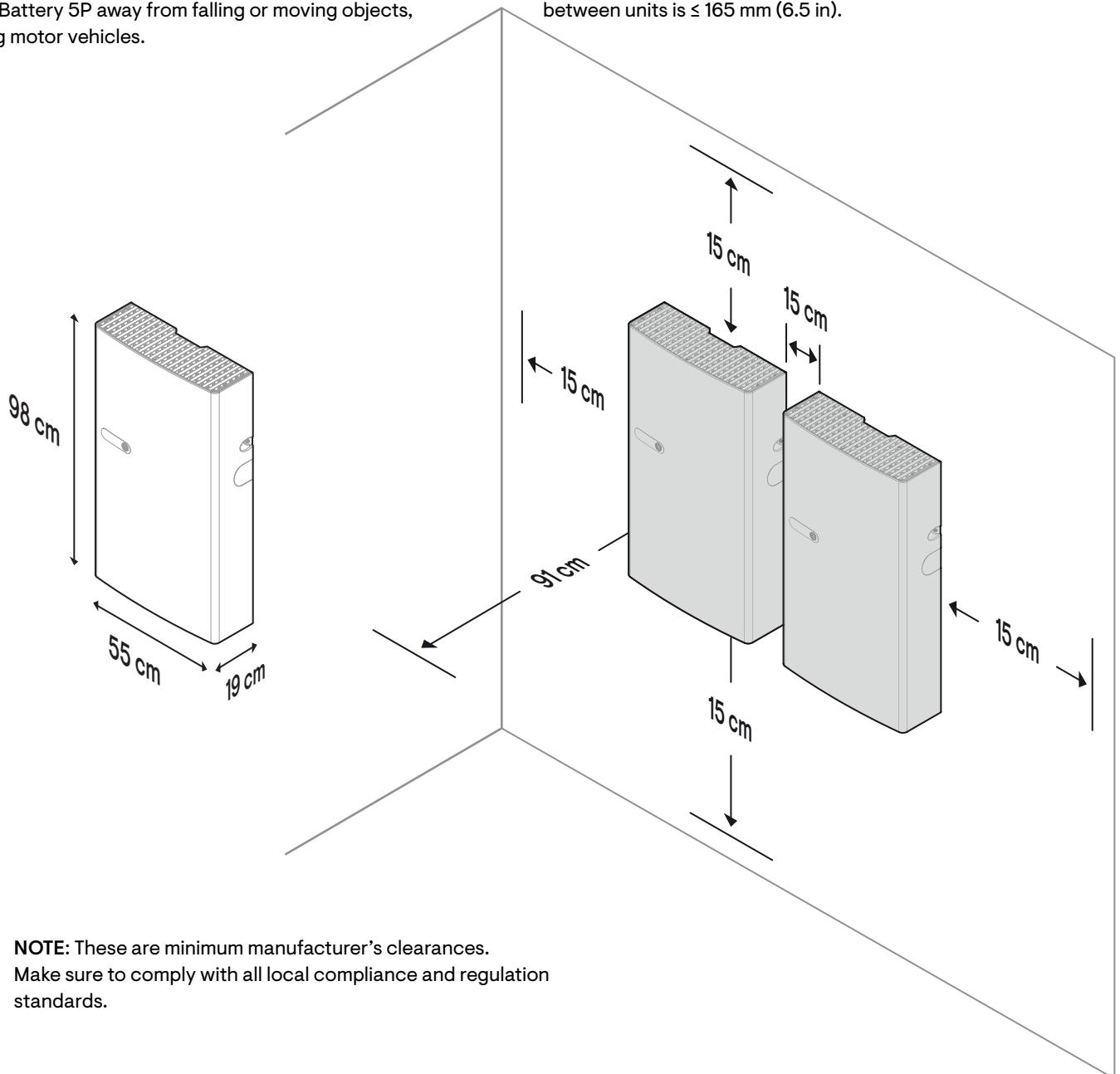

NOTE: These are minimum manufacturer's clearances. Make sure to comply with all local compliance and regulation standards.

Section A - Mounting the product

Step 2: Mounting surface

1. Select a location where the tilt from vertical is less than 5° as shown in the following image:

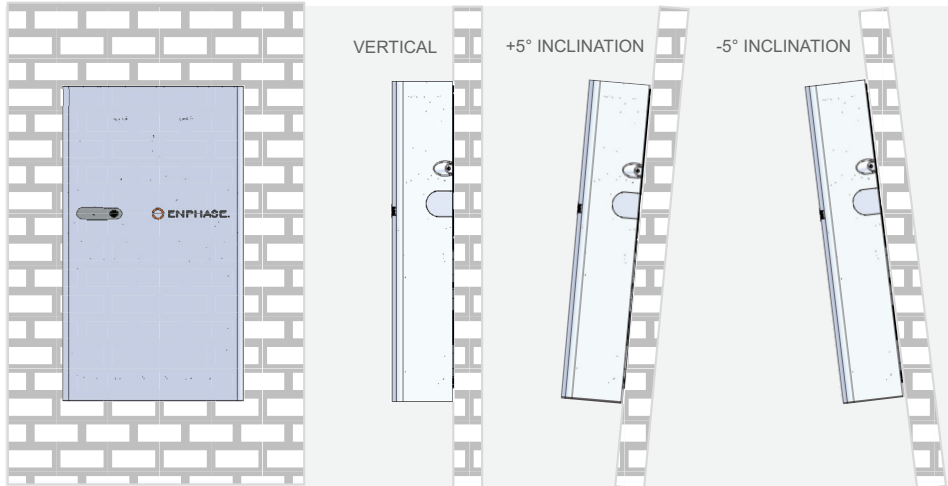

2. Make sure the mounting surface flatness is within 2 mm between boundary lines as shown in following image:

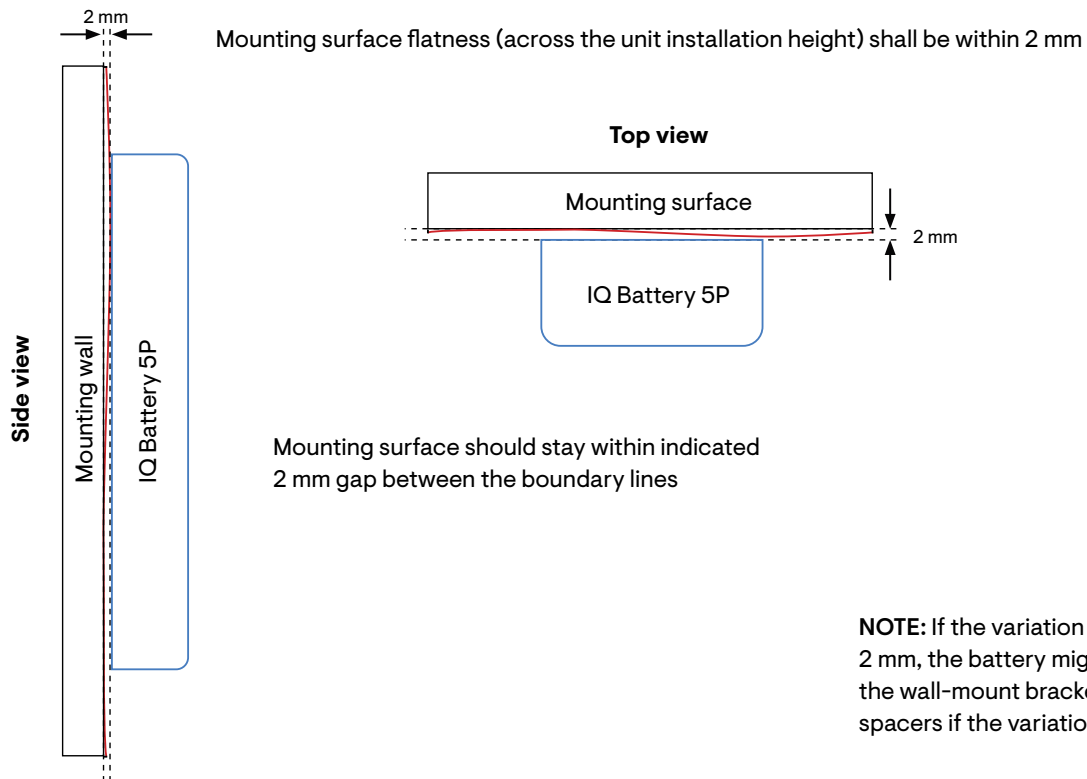

NOTE: If the variation of the flatness is more than 2 mm, the battery might not properly sit on the wall-mount bracket through key holes. Use spacers if the variation is more than 2 mm.

Section A - Mounting the product

Step 3: Install the wall-mount bracket

Install the wall-mount bracket as per the following instructions:

1. Starting at installation position closest to the power source, mark a levelline on the wall as a guide.

 Multiple risks. Make sure not to drill into or attach to electric wiring or pipes in the wall.

2. The wall-mount bracket comes in two parts: bottom bracket that carries the weight of IQ Battery 5P and the top shield that covers the back of the IQ Battery 5P.

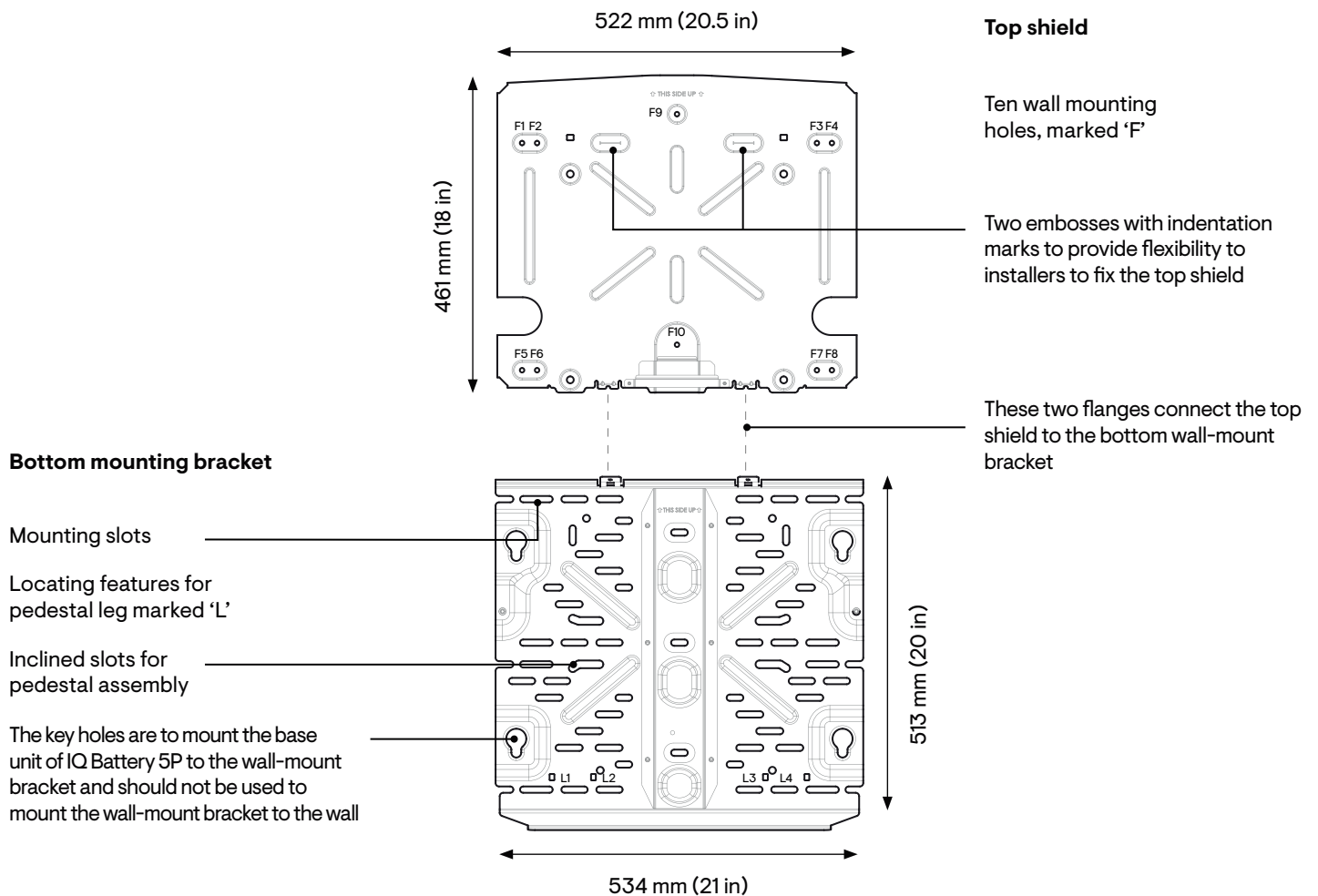

Section A - Mounting the product

- Position the mounting bracket on the wall and fasten it using the mounting slots.
- Position the ground contact flange of the top shield on that of the mounting bracket and align the screw slot/hole.
- Fasten the top shield to the wall using the mounting holes as shown below.
- Fasten top shield to the mounting bracket at the ground contact flange using two M4 screws (torque to 1.5 N m) to complete the assembly.
- Use M8 screws/lag bolts (or masonry attachments for masonry wall) to attach the bracket using one screw/lag bolt and washer for each slot (9.2 mm/0.36 in). Use minimum of three screws/lag bolts for single stud mounting and four screws/lag bolts for dual stud mounting. Tighten all screws to manufacturer's specified torque values.
- Make sure the wall-mount bracket is solidly attached to the wall.
- Use minimum two M6 in screws for single stud mounting and five M6 in screws for dual stud mounting to fasten the top shield to the wall.

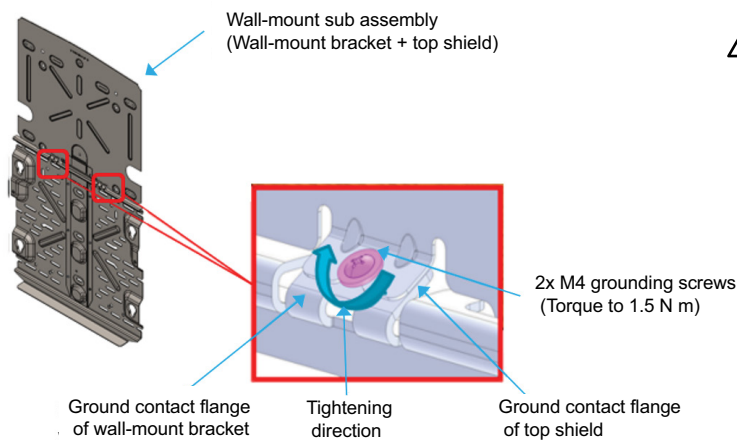

 Risk of injury and equipment damage. Do not mount an IQ Battery 5P on a bracket that is not properly mounted.

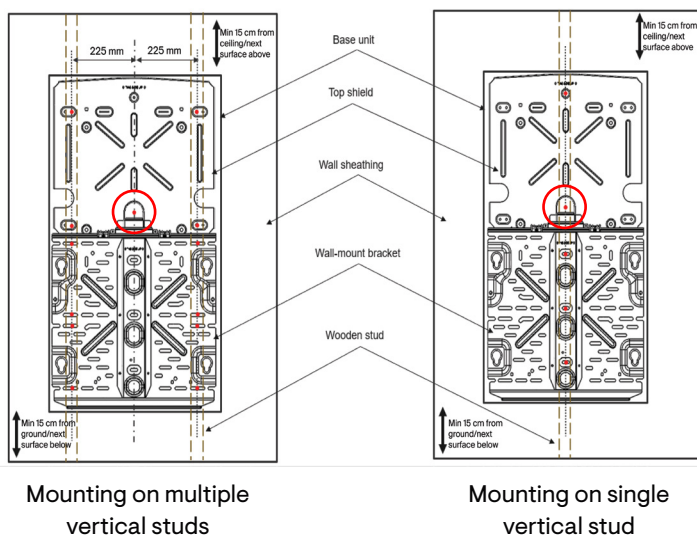

NOTE: Ensure to always fasten the screw in the encircled hole.

Section B

Installing IQ Battery 5P

Step 1:

Prepare to install IQ Battery 5P on mounting bracket

1. Remove the ID cover from the packaging and keep it aside.
2. Use the reusable lifting handles (sold separately) and check that the plungers are extended and ready to engage into the IQ Battery 5P slots.
3. Align left handle on left side of IQ Battery 5P and insert it into the slots and slide towards the top of IQ Battery 5P enclosure until it locks into place. Check that the handle is secure.
4. Repeat on the other side with the right handle.

 Risk of injury and equipment damage. Two people are required to lift IQ Battery 5P.

 Lift IQ Battery 5P from the packaging using the handles and make sure the battery's front side is facing towards you.

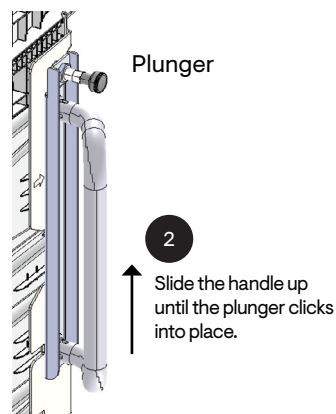
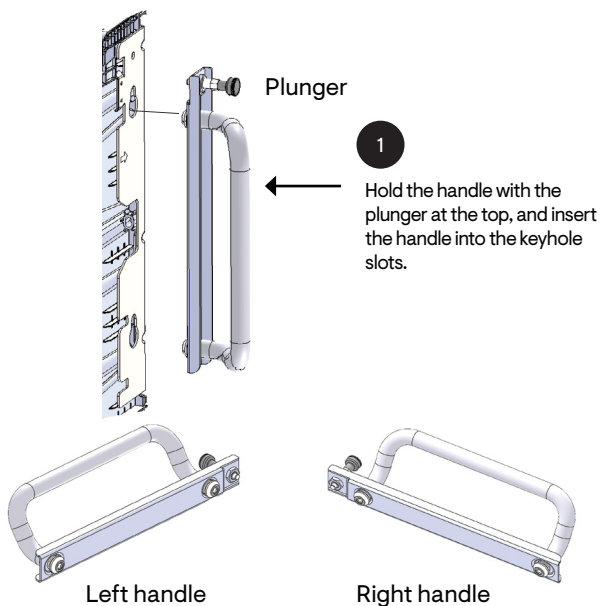
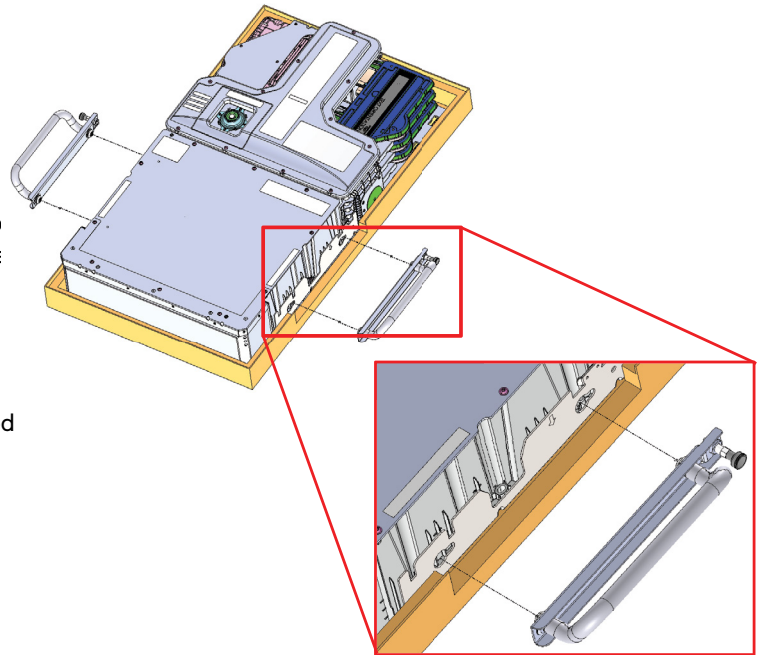

Section B - Installing IQ Battery 5P

5. Two persons together must lift the IQ Battery 5P unit from the packaging using the handles and place it in upright position on a flat surface.
6. IQ Battery 5P can have the field cable entry from back, left, or right side. Finalize the side from where the field cable enters and leaves IQ Battery 5P. Use the following configuration image to decide the cut-out for all the units.

 Risk of electric shock. The DC control switch must be in the OFF position before performing this step.

NOTE: The rear entry can support the conduit with diameter of 1/2 in (13 mm) to 3/4 in (19 mm) while side entry can support the conduit with diameter of 1/2 in (13 mm) to 1-1/4 in (32 mm). Follow manufacturer recommended instructions for conduit installation.

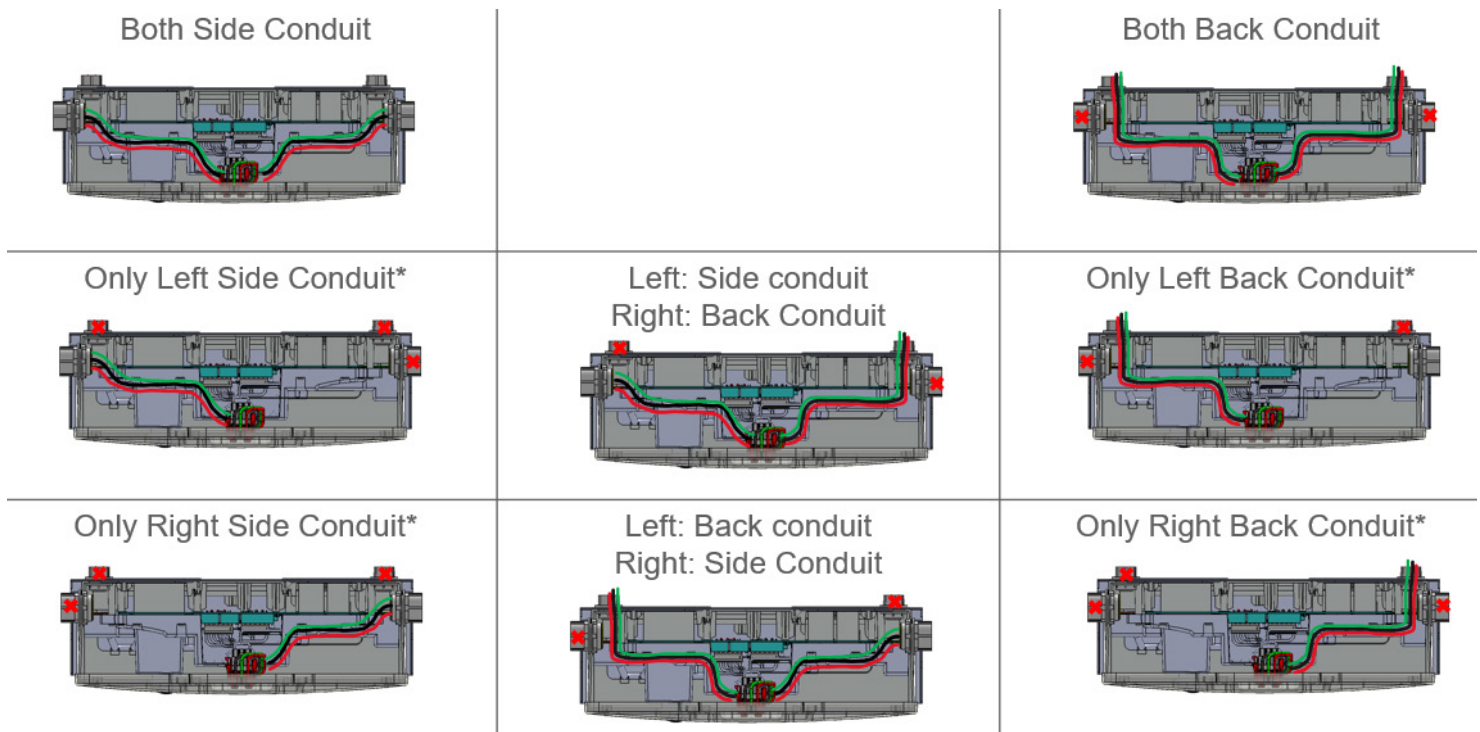

* One side conduit configuration is supported only if system has one IQ Battery 5P or for the unit last in the daisy chain farthest from the IQ System Controller.

Section B - Installing IQ Battery 5P

7. Open the front wiring cover by unfastening the 11 captive screws (torque to 1.5 N m) from the wiring cover. Use electric drive; do not use impact drives/impact drills.

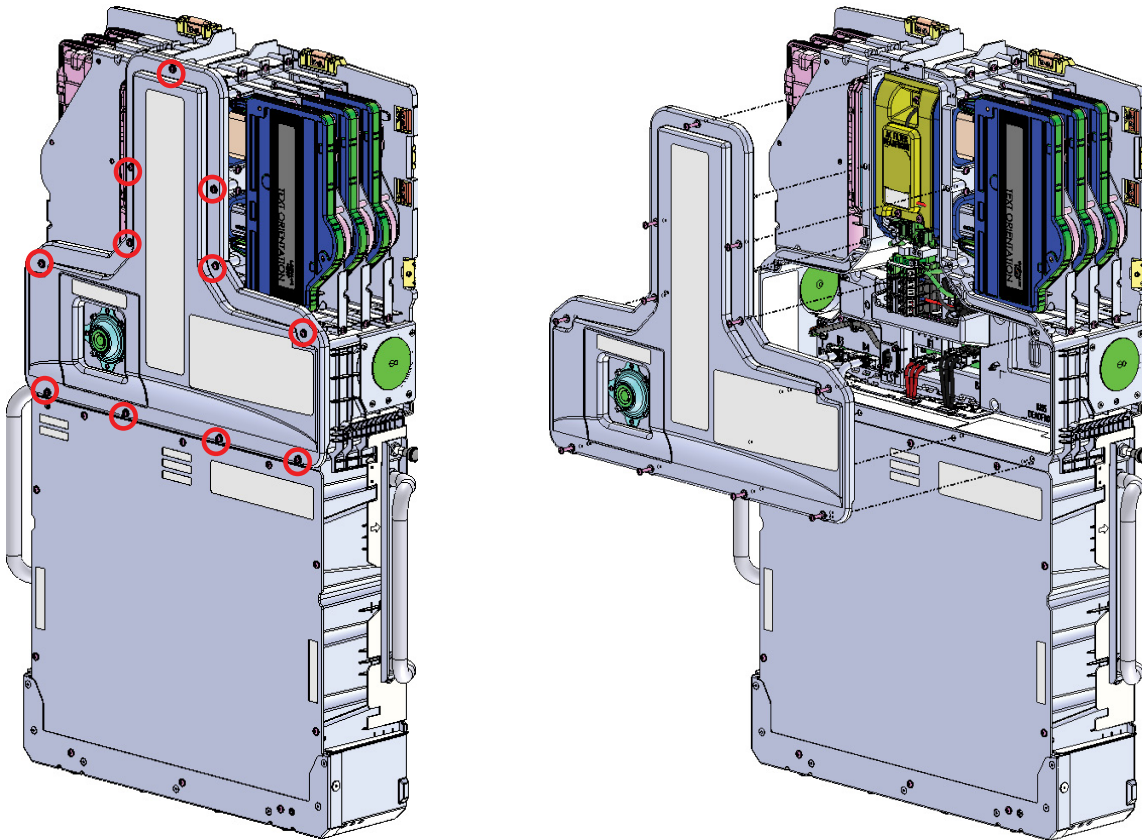

Section B - Installing IQ Battery 5P

8. Drill the appropriate cutout on either the back or side of the unit or on both based on configurations. The rear entry can support the conduit with diameter of 1/2 in (13 mm) to 3/4 in (19 mm) while side entry can support the conduit with diameter of 1/2 in (13 mm) to 1-1/4 in (32 mm). L and N terminals can accept maximum cable size of 30 mm². GND terminal can accept maximum cable size of 10 mm².

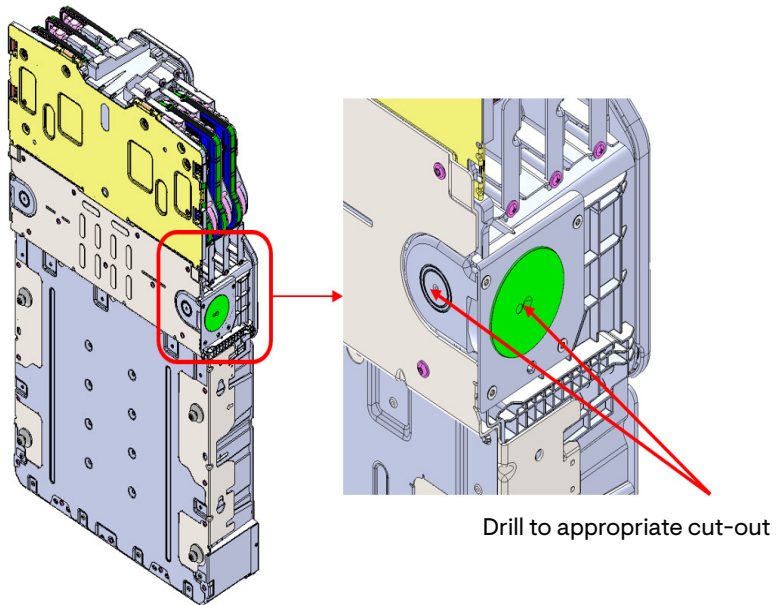

⚠ Ensure that drilling machine do not touch any internal components or wall.

⚠ Ensure to clean the debris from inside the battery unit after drilling.

Section B - Installing IQ Battery 5P

9. Hold the IQ Battery 5P straight, align, and insert four mount bolts on the battery unit into the mounting bracket key holes and slide it down.

NOTE: Use lift assist to avoid any mishap during lifting.

10. Remove installation handles.

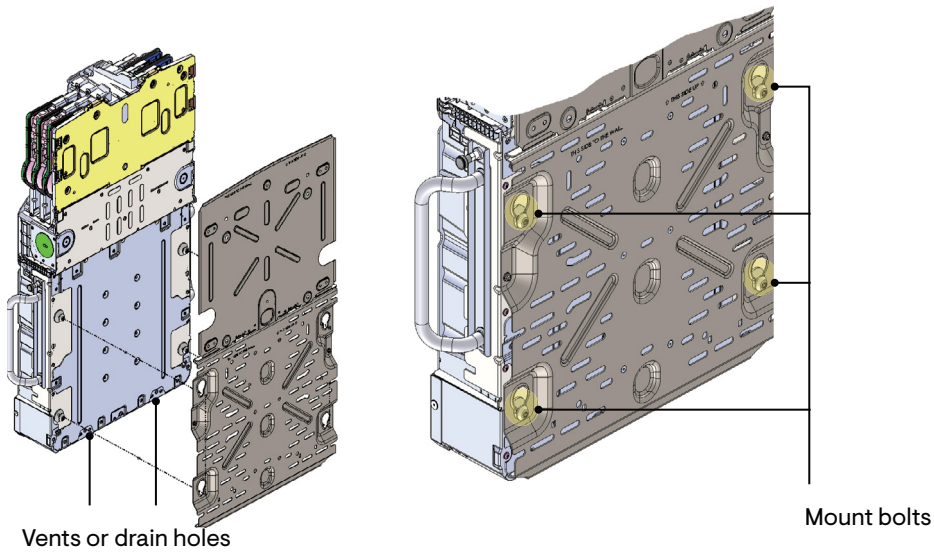

11. Secure the battery unit on the wall-mount bracket using two

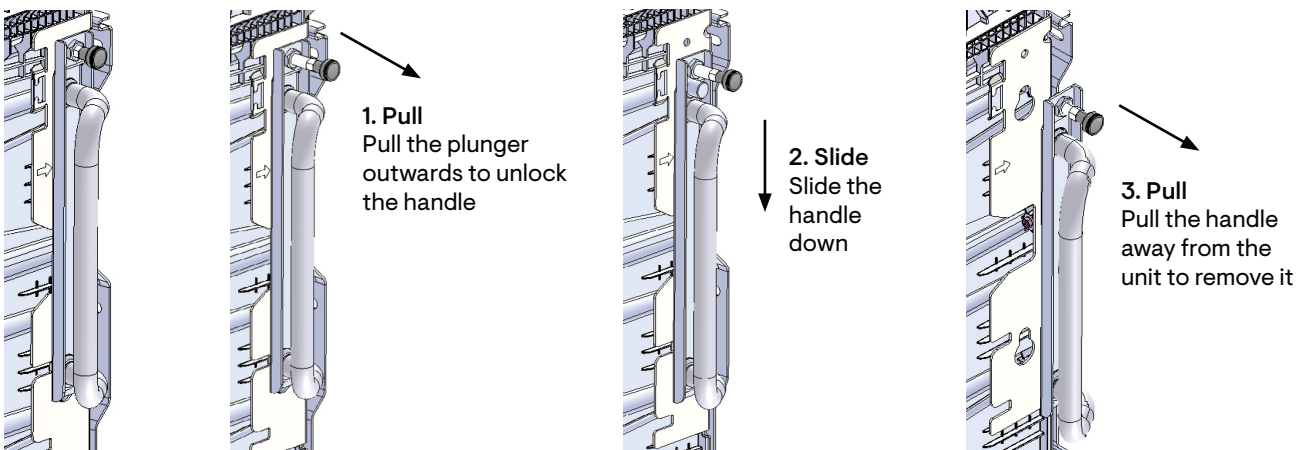

Section B - Installing IQ Battery 5P

seismic screws (torque to 5.6 N m).

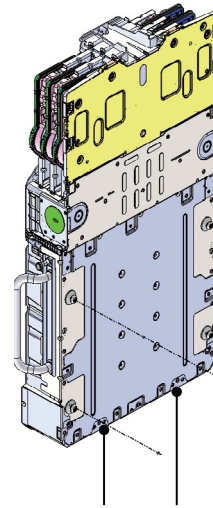
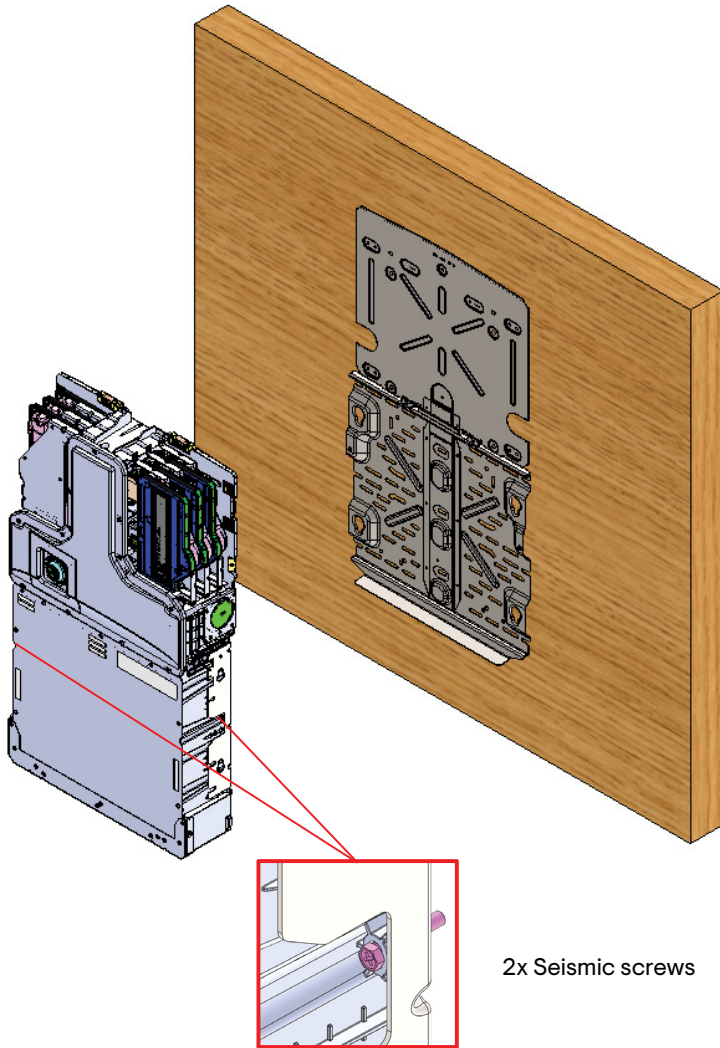

Vents or drain holes

! The vent or drain holes provided at the back of the unit serves the dual purpose of natural ventilation and condensation drainage. Blocking these holes can affect the functionality of the product.

Section B - Installing IQ Battery 5P

Step 2: Prepare for field wiring

1. Connect the following connectors to the BMS board in following sequence:
 - i. B3: Temperature sense connector termination (black)
 - ii. B4: Battery Voltage sense connector termination (multicolored)
 - iii. B1: Battery DC +ve connector termination
 - iv. B2: Battery DC -ve connector termination
 - v. CS1: Control switch intermediate connector termination

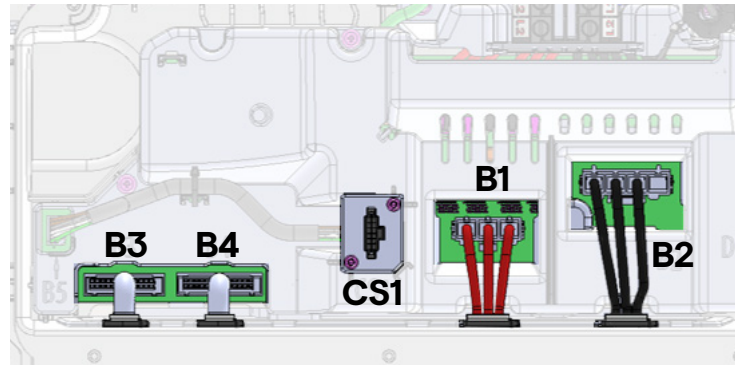

NOTE: Ensure that all the connectors are latched properly and clicking sound is observed.

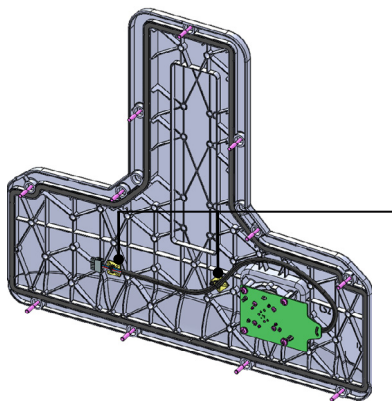

Cut two cable ties and insert the connector on CS1 in BMS board

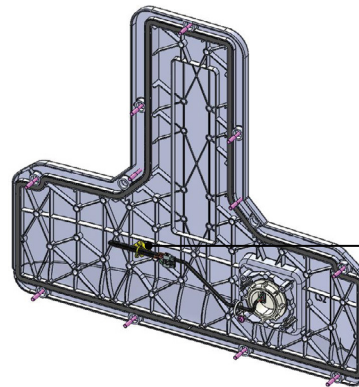

Cut one cable tie and insert the connector on CS1 in BMS board

NOTE: There are two variants of control switch available in IQ Battery 5P. The control switch cable is secured to wiring cover using cable ties. Select the control switch available at site based on below images and cut the cable ties on the wiring cover to access the control switch cable.

2. Fasten (torque to 1.5 N m) the 11 captive screws at the wiring cover as shown. Use electric drive; do not use impact drives/ impact drills.

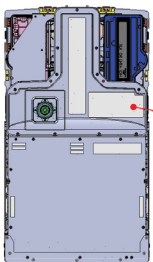

CAUTION! FOLLOW THE SEQUENCE SHOWN TO PARTIALLY TORQUE THE 11x SCREWS. FULLY TORQUE ALL THE SCREWS TO MAX 1.5 ± 0.15 Nm AT MAX 1000RPM, ONLY AFTER ALL OF THEM ARE IN POSITION.		SCREW FASTENING SEQUENCE
INSTRUCTIONS TO REMOVE THE WIRING COVER PRIOR TO INSTALLATION / SERVICING	INSTRUCTIONS TO ASSEMBLE THE WIRING COVER AFTER INSTALLATION / SERVICING	
1. LOOSEN THE 11x SCREWS TO REMOVE THE WIRING COVER FOR INSTALLATION/ SERVICING. REFER QIG FOR MORE DETAILS. 2. FOR SERVICING, MOVE THE WIRING COVER GENTLY AWAY FROM THE UNIT TO FIND THE CONTROL SWITCH (CS1) INTERMEDIATE CONNECTION AND UNPLUG IT FROM THE PANEL MOUNT CONNECTOR BEFORE REMOVING WIRING COVER COMPLETELY.	1. PLUG THE CONTROL SWITCH INTERMEDIATE CONNECTOR (CS1) TO THE PANEL MOUNT CONNECTOR AND ENSURE THAT THE CABLE IS ROUTED INSIDE THE UNIT PROPERLY BEFORE ASSEMBLING THE WIRING COVER COMPLETELY. 2. FASTEN THE SCREWS AS PER ABOVE INSTRUCTIONS. REFER QIG FOR MORE DETAILS.	

Section C

Wiring

Install conduit/raceway adapter and field wiring

1. When installing a single IQ Battery 5P unit, insert the conduit in the cutouts drilled in previous step.

NOTE: Use a “chase nipple” & “rigid coupling” as spacer for connecting 90° fitting to the battery. This avoids interference between the 90° fitting and battery ID cover. Make sure the joints are properly fastened and are watertight.

2. If installing more than one IQ Battery 5P, insert the conduit on the side of the unit closest to the AC disconnect. If an IQ System Controller is in line-of-sight, the breaker on IQ System Controller can service as the AC disconnect.
3. Use either raceway adapter or conduit in between the IQ Battery 5P units based on following:
 - Use conduit between units if distance between units is > 165 mm (6.5 in).
 - Use a raceway adapter between units only if the distance between units is ≤ 165 mm (6.5 in) and they are at the same level. Raceway adapters can be provided by Enphase (sold separately) and have the following configuration:

BATTERY SPACING WITH COVER (A)	CORRECTED RACEWAY ADAPTER LENGTH (B)	SPACING BETWEEN WALL-MOUNT BRACKETS (C)
165 mm (6.5 in)	220 mm (8.6 in)	181.1 mm (7.13 in)
152 mm (6.0 in)	220 mm (8.6 in)	168.4 mm (6.63 in)
146 mm (5.75 in)	220 mm (8.6 in)	162.05 mm (6.38 in)

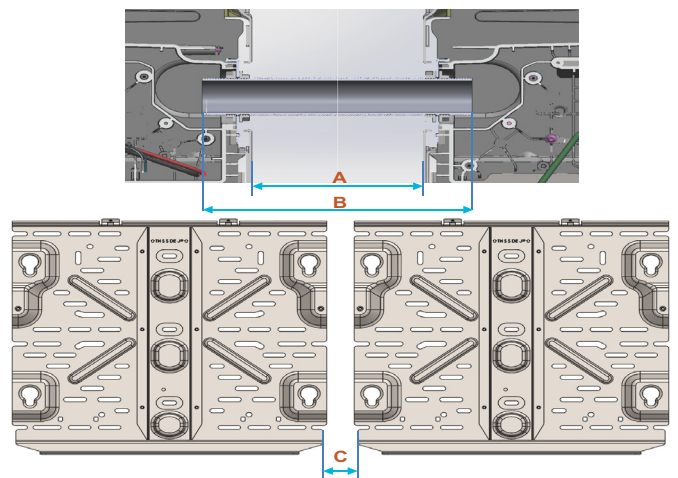

Section C - Wiring

- Starting from the unit closest to the IQ System Controller, pass the power and control communication conductors through the conduit and make the two ends of conductors available on the unit and IQ System Controller side.
- Connect the power conductors and control communication cables on the terminal blocks (L, N, and Ground) and the control communication connector respectively. Each terminal block accepts 6 mm² to 30 mm² conductors. Tighten L and N terminals to 2.5 N m (27 lb-in), and small Ground terminal to 1.5 N m (13.2 lb-in).

NOTE: Do not disturb the factory termination connections on terminal blocks during field wiring.

- If connecting more than one IQ Battery 5P, connect power conductors between the terminal blocks and control communication cables between the CTRL connectors of these units such that the conductors connect on the right side of one unit and the left side of another unit after passing through conduit or raceway adapter. Repeat these steps until you arrive at the unit that is farthest from the IQ System Controller.

NOTE: Power and control communication cables will run in parallel through conduits and raceway adapters.

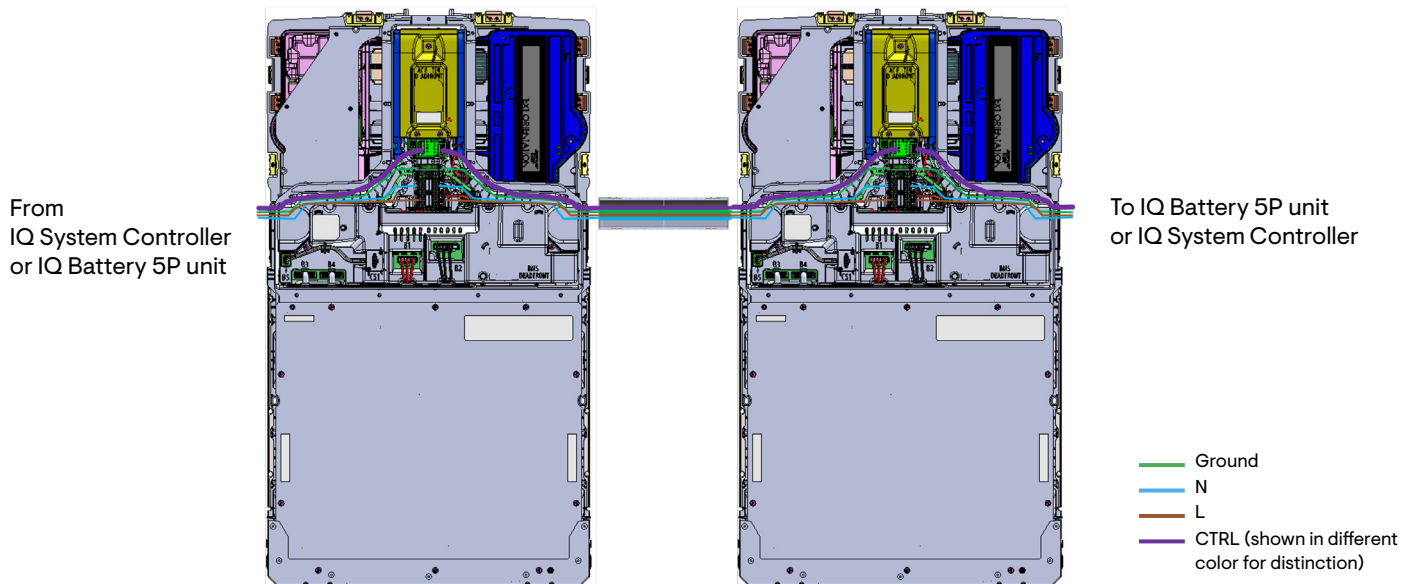

Section C - Wiring

- Follow the jacket stripping length and connect the control communication wires to the 4-pin connectors shown in the following image. Remove the resistor from the control connectors from all the units except the one farthest from IQ System Controller in the daisy chain

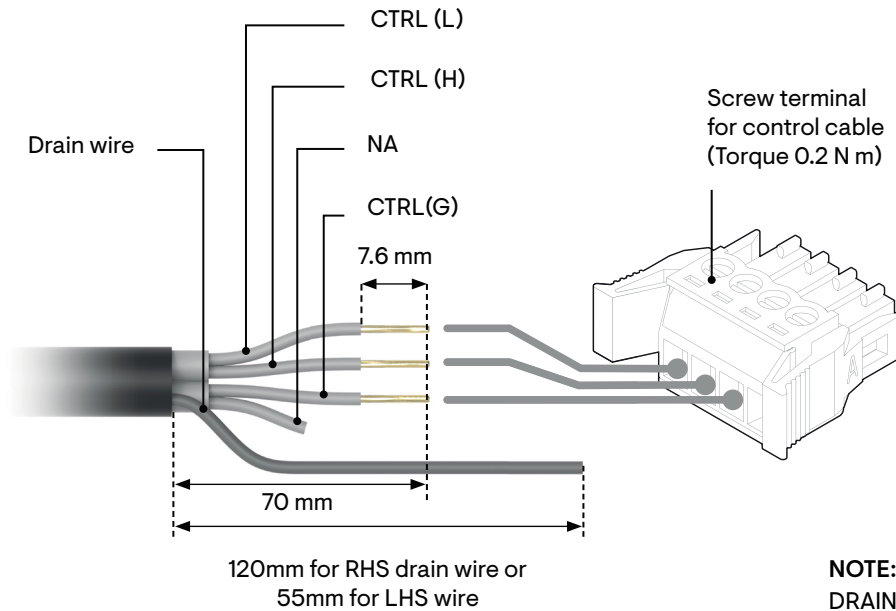

NOTE: Drain wire should be terminated only at one DRAIN connector while the other DRAIN connector shall remain unconnected within each IQ Battery 5P.

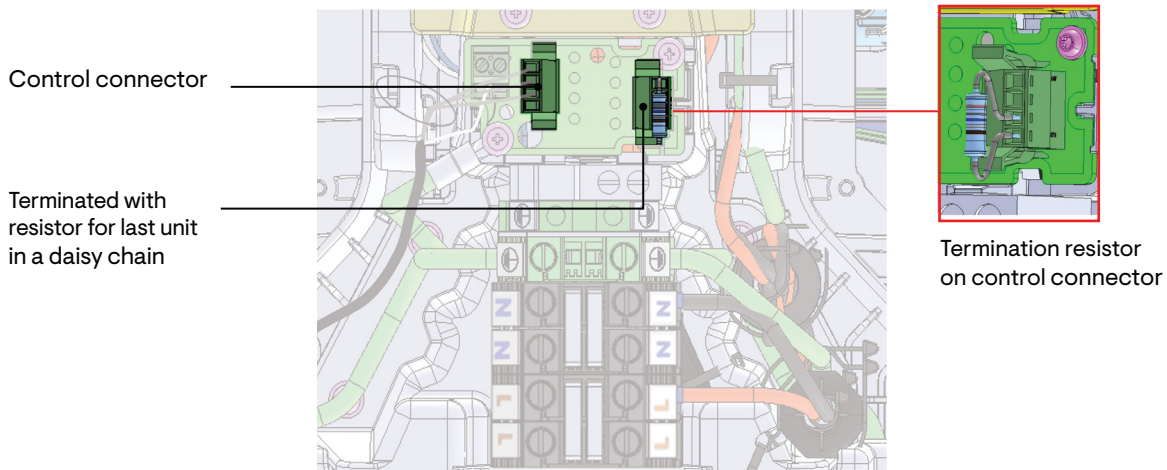
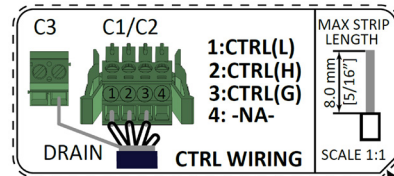

Section C - Wiring

8. Route the conductors between conduit and terminal blocks using anchoring points as shown in the following figure:

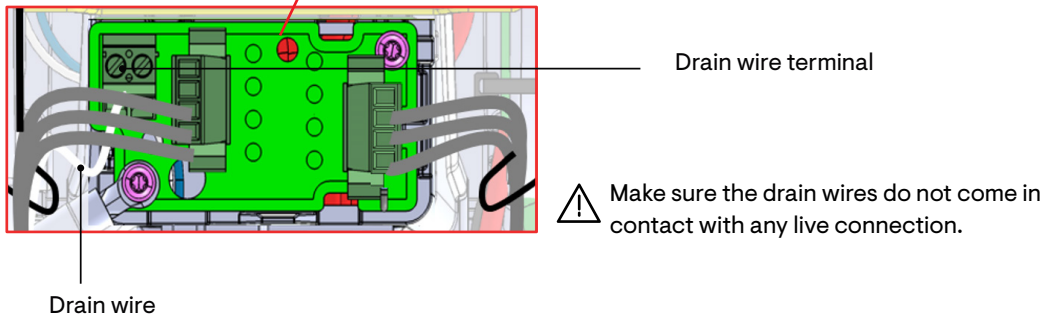
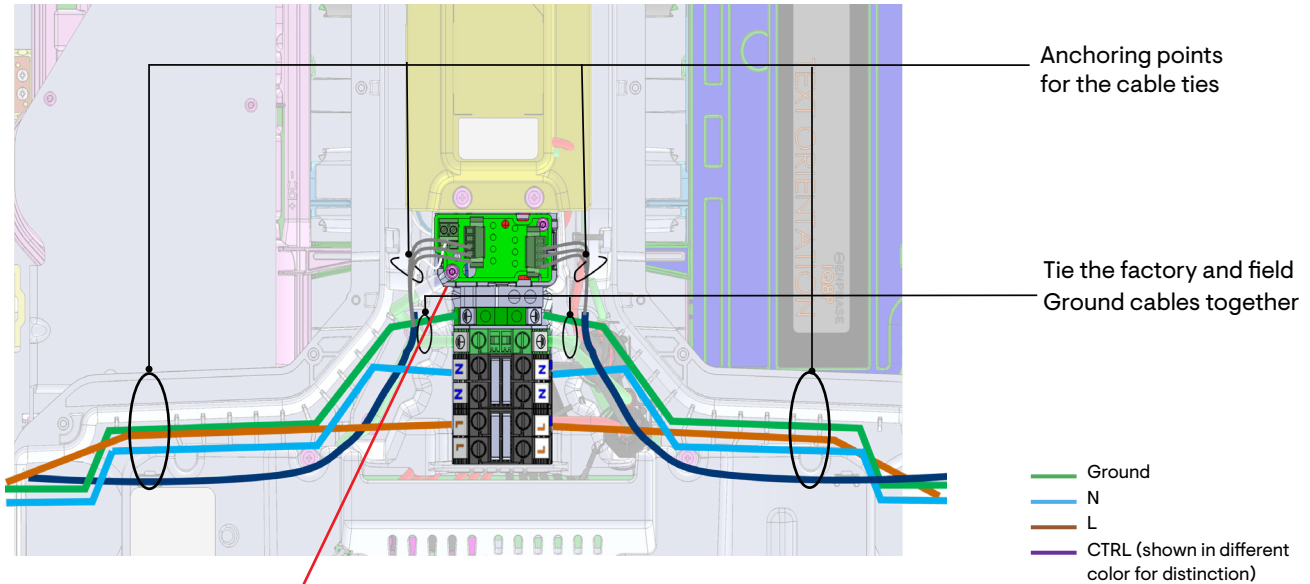

9. After all wires in the field wiring compartment are connected and secured, make sure there are no exposed conductors.
10. Make sure the IQ Battery 5P unit that is farthest from IQ System Controller has a cutout only on one side and all other sides are covered.
11. Apply AC power to the IQ Battery 5P circuits. Using a voltmeter, make sure voltage between L and N on the terminal blocks of each IQ Battery 5P unit measures 230 VAC (211-264 V).
12. If the voltage is within the range as required by local codes, turn off the AC power supply.

Section D

Close and energize the system

⚠ Before energizing, make sure that all IQ Batteries in the system are properly installed and conductors terminated.

⚠ Risk of equipment damage. Make sure no wires are pinched before replacing the cover.

1. Make sure the wiring cover(s) for all IQ Batteries in the system are closed and secured.

NOTE: Ensure the serial number label on the ID cover matches with that on the heatsink before assembling ID cover.

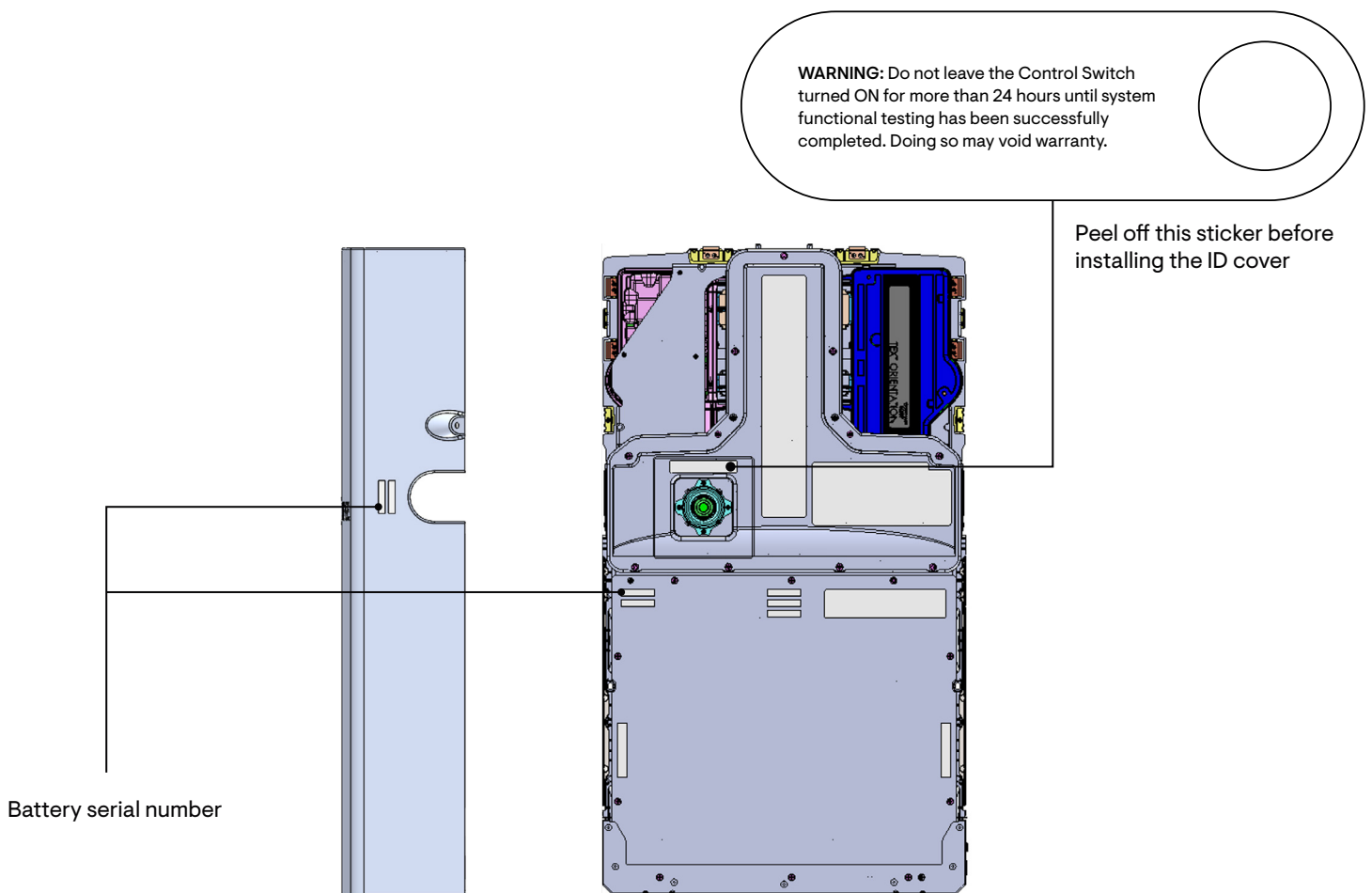

Section D - Close and energize the system

- Slide on the IQ Battery 5P cover in the indicated direction such that the tab of the cover in the highlighted region rests and slides on the latch in the IQ Battery 5P chassis.

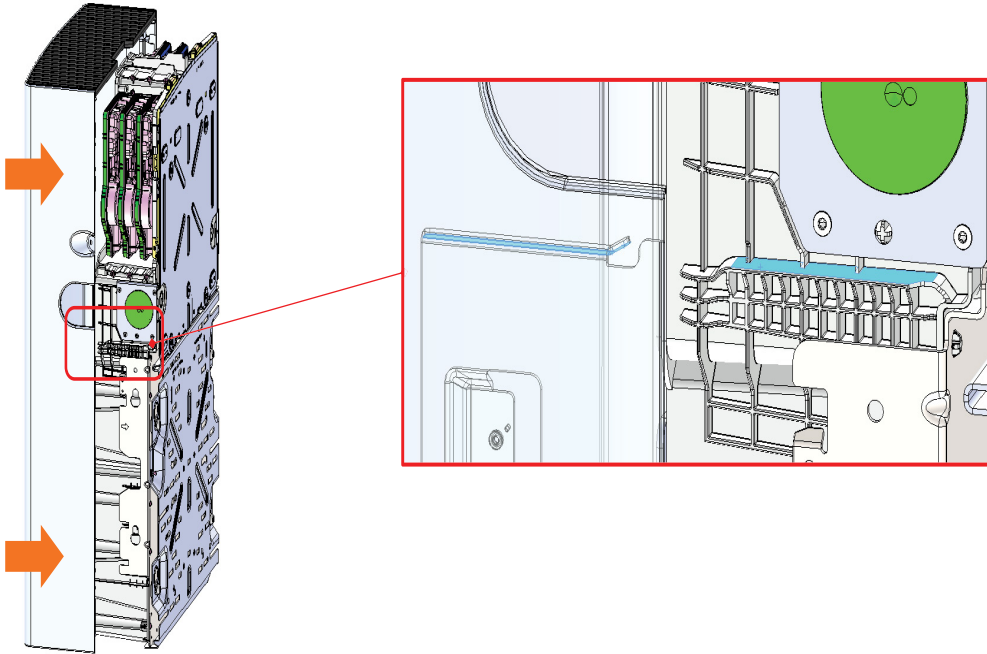

- Before releasing, pull out the lower edges while sliding in the cover and make sure the tabs are locked to the back plate as shown in the following figure:

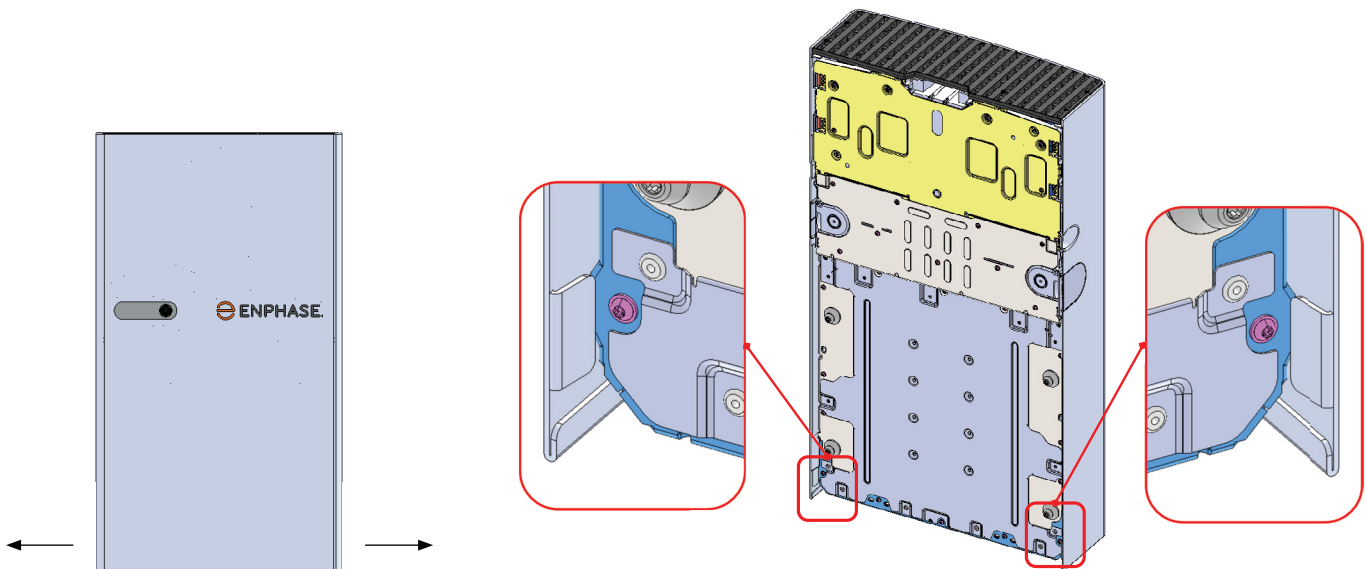

Section D - Close and energize the system

4. Push in the top portion of the cover as shown and make sure that the cover is locked in place as indicated.

Before step 4

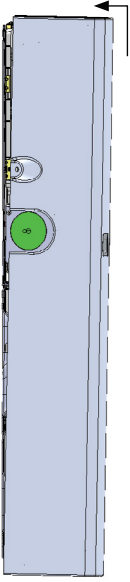

After step 4

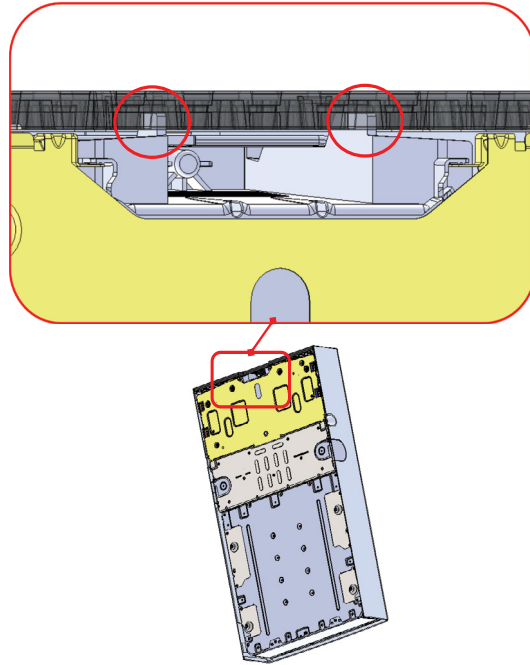
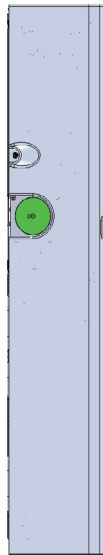

5. Fasten cover to the extension backplate using the two M5 Phillips hex head screws (torque to 3.1 N m)

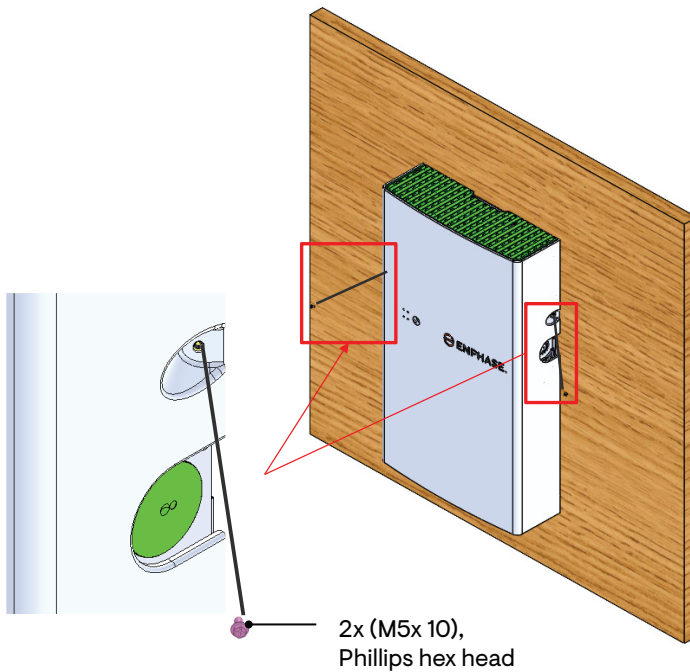

Section D - Close and energize the system

- If the spacing 'A' between the units is < 165 mm (6.5 in), screwdriver of maximum length 150 mm should be used to fasten cover to the extension backplate.

NOTE: The screw is accessible at 40° to the wall.

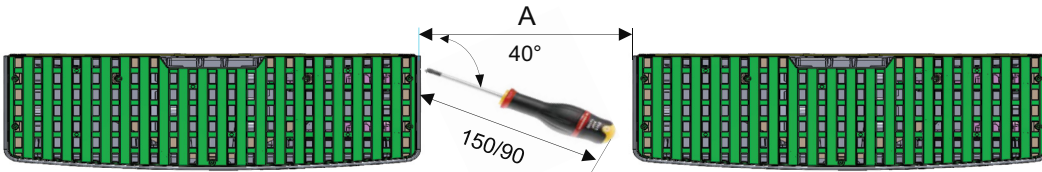

- After installing the cover,
 - If the conduit hub is installed, the conduit cover is not necessary.
 - If the conduit hub is not installed, then the conduit cover should be installed to cover the opening in the IQ Battery 5P cover on the other side.

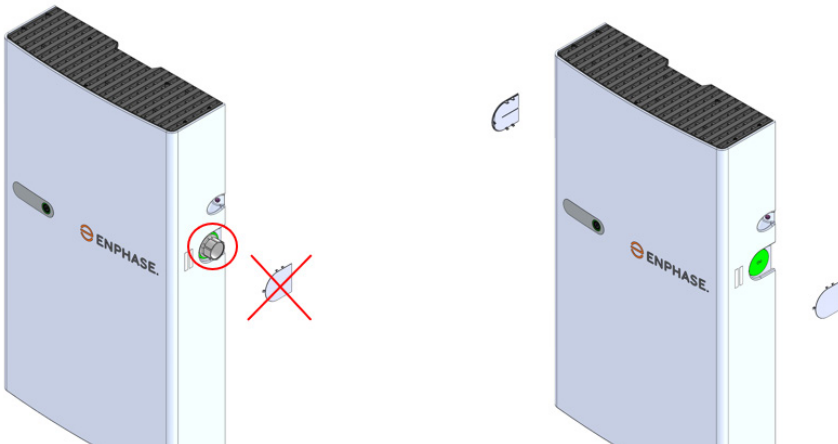

- Apply AC power to the IQ Battery 5P circuits.
- Turn ON the DC control switch. A green LED will glow around the control switch. The IQ Battery 5P is ready for commissioning.



Do not leave the DC control Switch in ON position without AC power supply available. This will deplete the battery and may lead to a condition where battery cannot be turned ON and cannot be commissioned.

Disassembly of IQ Battery 5P cover

Refer to these instructions when you need to remove the cover.
This is not a required step prior to commissioning.

1. Remove the conduit covers from both sides of the IQ Battery 5P cover.

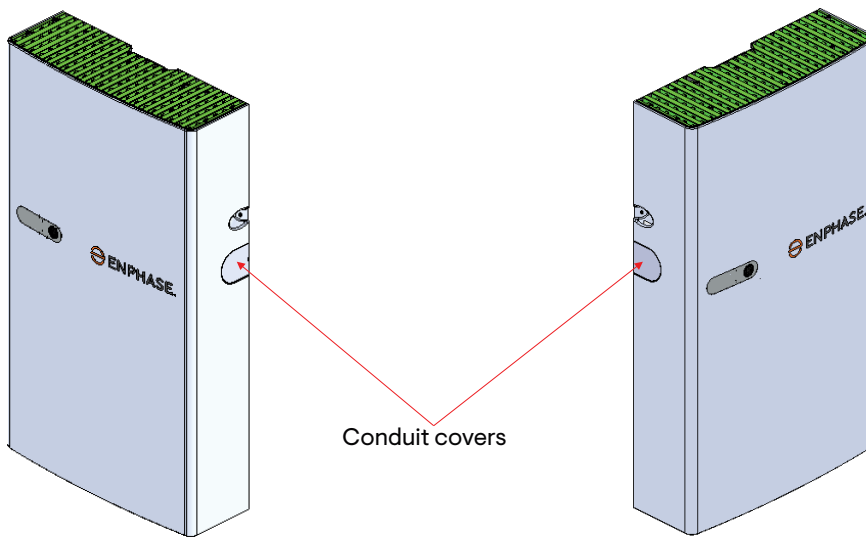

2. Remove the two M5 Phillips hex head screws (torque to 3.1 N m) which are used to affix the cover to the extension backplate.

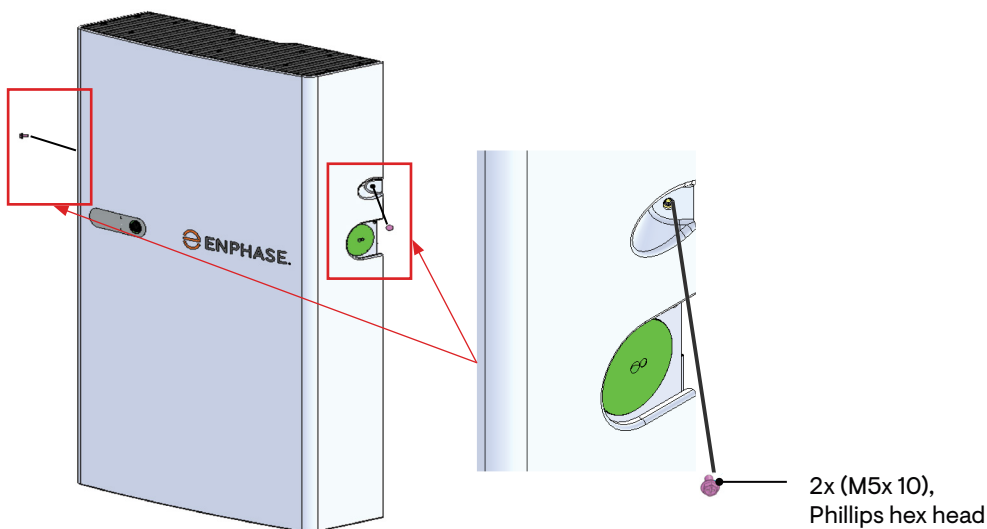

Disassembly of IQ Battery 5P cover

- Using the hand access slot, pull the top plastic grill slightly in the direction shown below.

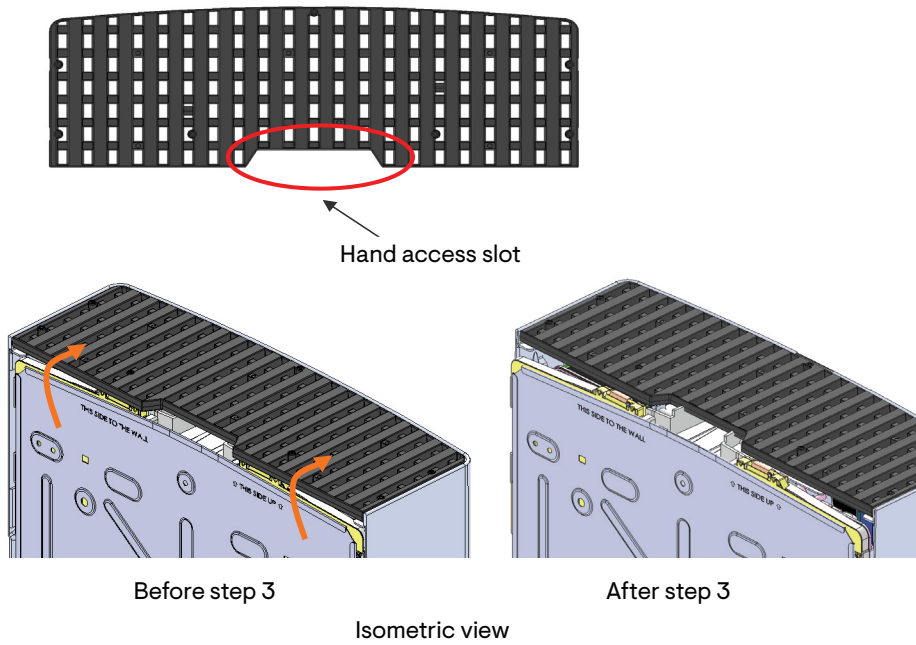

- Unlock the top plastic cover from the ribs highlighted in yellow.

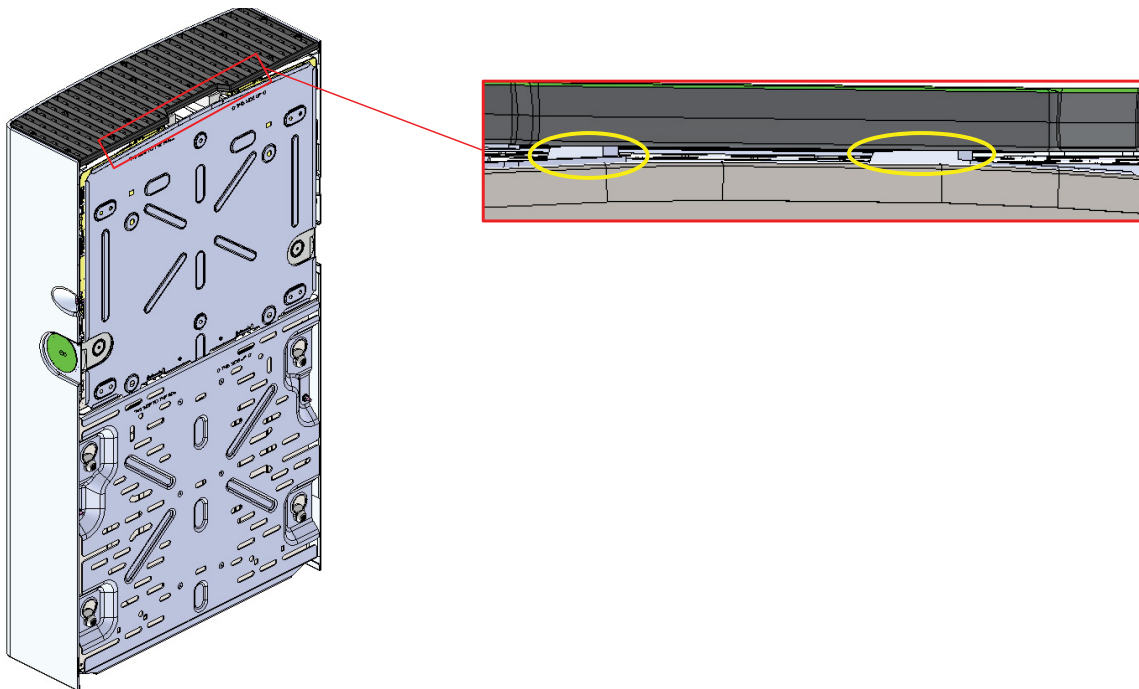

Disassembly of IQ Battery 5P cover

5. Make sure the cover reaches the position shown in the side view image after the completion of this step.

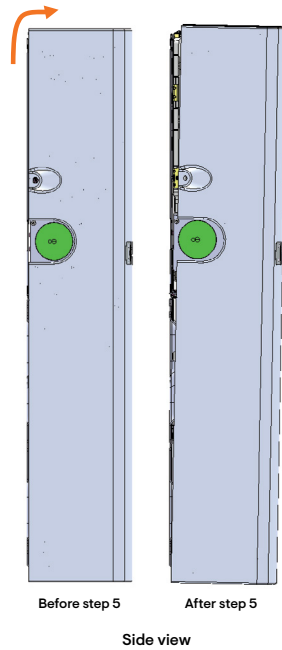

6. Pull out the lower portion of the cover (in order to unlock the highlighted angular tabs) and move it away from the wall slightly as per the directions shown the following figure (back view).

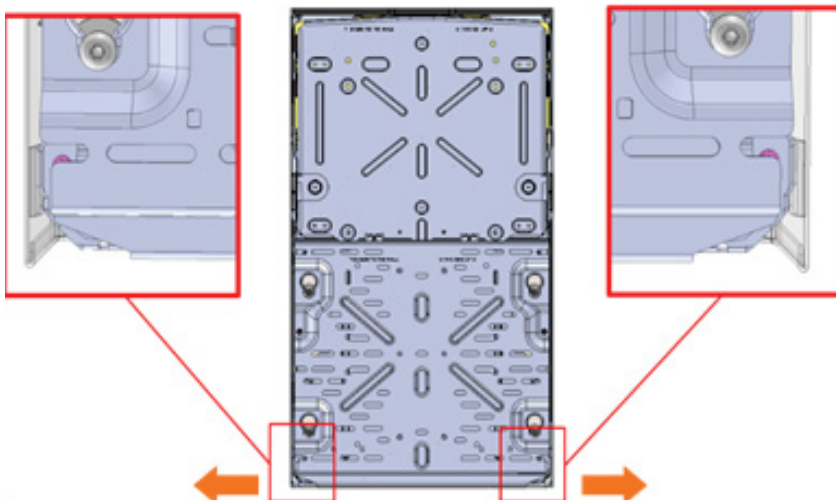

Disassembly of IQ Battery 5P cover

7. Make sure the cover reaches the position shown in the front view.

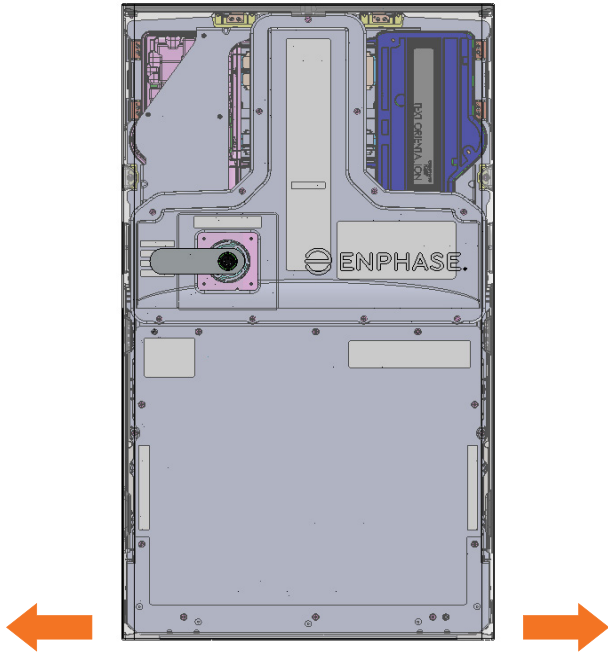

8. Pull the cover off in the indicated direction.

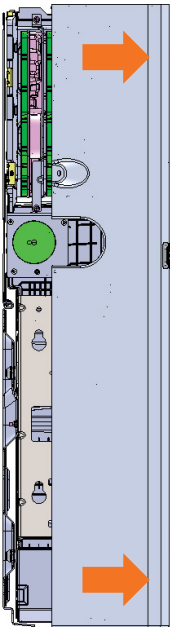

Configure and activate

1. Use the Enphase Installer App to commission the IQ Battery(ies). Once connected to the IQ Gateway Metered, refer to the Enphase Installer App help topics for more information.



2. Peel off following sticker after functional test is complete.

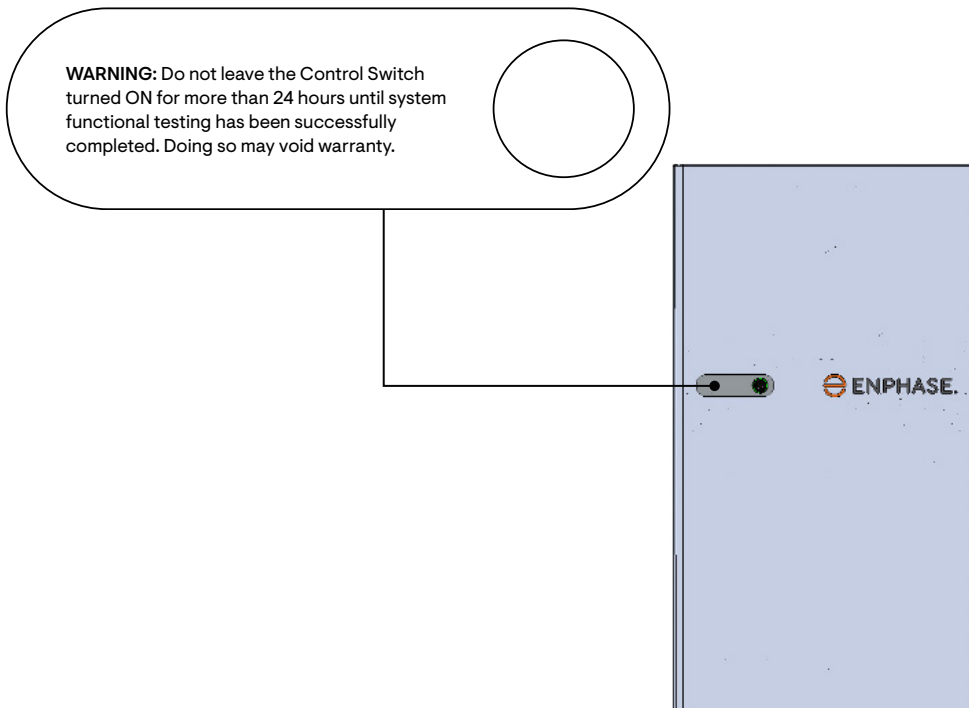

3. After the IQ Gateway has detected the IQ Battery(ies), the IQ Battery 5P LEDs operate as described in the following section.

Operation

LED overview

After being commissioned, the LED flashes yellow while each IQ Battery 5P boots up. If the LED rapidly flashes green for more than two minutes, the battery is in trickle charge mode and will remain so until it reaches a minimum state of charge (up to 30 minutes). After the IQ Battery 5P is booted up, the LED becomes blue or green depending on the charge level. If the LED flashes yellow after one hour or changes to a flashing red state, contact Enphase Customer Support at enphase.com/contact/support.

STATE	DESCRIPTION
UNCOMMISSIONED	
Flashing blue	After booting up, IQ Battery 5P has paired with an IQ Gateway but has not passed the commissioning three-way handshake to confirm that it is an Enphase device
Flashing green	After passing the three-way handshake with the IQ Gateway
AFTER COMMISSIONING (NORMAL OPERATION)	
Rapidly flashing yellow	Starting up/establishing communications
Red double flash	Error. See “Troubleshooting”
Solid yellow	Not operating due to high temperature. See “Troubleshooting”
Solid blue or green	Idle. Color transitions from blue to green as state of charge increases. Check Enphase Installer Platform for charge status
Soft pulse blue	Discharging
Soft pulse green	Charging
Soft pulse yellow	Sleep mode
Red triple flashes	DC switch OFF
Red one second flash	Rapid Shutdown mode
Off	Not operating. See “Troubleshooting”

Operation

Operating mode and set points

IQ Battery 5P supports multiple storage interactive system modes based on usage.

1. Using Enphase App, select “Menu” > “Settings” > “Battery Storage”.
2. Select one of three battery modes:
 - Self-consumption mode (default, no setting change required)
 - Savings mode
 - Full backup

For more information on Operation modes, refer to the Storage System Owner’s guide at enphase.com/en-au.

Operation

Troubleshooting

If the IQ Battery(ies) are not operating correctly, follow these troubleshooting steps. If the issue persists, contact Enphase at enphase.com/en-au.

1. If the IQ Battery(ies) do not operate, check the temperature in the room and increase cooling and/or ventilation as required. Check that the bottom, top, and sides of IQ Battery 5P have at least 15 cm (6 in) clearance from the wall.
2. If the IQ Battery 5P LED is off, turn off the breaker for the branch circuit, wait for at least one minute, and turn it back on.

NOTE: IQ Battery 5P has multiple field replaceable parts. These must be replaced by trained service personnel. Contact Enphase Customer Support before replacing any part.

NOTE: During a brownout or blackout, IQ Battery 5P powers down automatically. This is normal. When power is restored, it automatically starts up again.

3. If you do not see IQ Battery 5P information in the Enphase App, check that the IQ Gateway and the Internet connection are working.
4. If the issue persists, contact Enphase Customer Support at enphase.com/en-au/support.

Limitation of Use:

Your IQ Battery 5P unit is not intended for use as a primary or backup power source for life-support systems, other medical equipment, or any other use where product failure could lead to injury, loss of life, or catastrophic property damage. Enphase disclaims any and all liability arising out of any such use of your IQ Battery 5P unit. Further, Enphase reserves the right to refuse to provide support in connection with any such use and disclaims any and all liability arising out of Enphase's provision of, or refusal to provide, support for your IQ Battery 5P device in such circumstances.

Shutdown procedure

1. Isolate the AC power by de-energizing the AC power supply to the IQ Batteries.
2. Using a multimeter, confirm that there is no AC power present.
3. Ensure the DC switch is in the OFF position using the following steps:
 - If the IQ Battery 5P LED is OFF, the DC switch is in OFF position and the IQ Battery 5P is in shutdown mode.
 - If the IQ Battery 5P LED (any color) is ON, press the DC switch once to turn it OFF and place IQ Battery 5P in shutdown mode.

Safety

IMPORTANT SAFETY INSTRUCTIONS. SAVE THESE INSTRUCTIONS.

This guide contains important instructions that you must follow during installation and maintenance of the Enphase IQ Battery(ies). Failing to follow any of these instructions may void the warranty (enphase.com/warranty). Refer to MSDS document and Safety Datasheet at enphase.com/en-au.

In Case of Fire or Other Emergency

In all cases:

- If safe to do so, switch off the AC breaker for the IQ Battery 5P circuit, and if an isolator switch is present, switch off the AC isolator for the IQ Battery 5P circuit.
- Contact the fire department or other required emergency response team.
- Evacuate the area.
- Contact Enphase Customer Support at <https://enphase.com/contact/support>

In case of fire:

- When safe, use a fire extinguisher. Suitable types are A, B, and C dry chemical fire extinguishers. Additional extinguishing media include carbon dioxide, or alcohol-resistant foams.

In case of flooding:

- Stay out of the water if any part of the IQ Battery(ies) or wiring is submerged.
- If possible, protect the system by finding and stopping the source of the water, and pumping it away.
- If water has contacted the battery, call your installer to arrange an inspection. If you are sure that water has never contacted the battery, let the area dry completely before use.

In case of unusual noise, smell or smoke:

- Ensure nothing is in contact with the IQ Battery(ies) or in the venting area of the IQ Battery(ies).
- Ventilate the room.

In case of electrolyte exposure:

The Enphase IQ Battery 5P has a lithium iron phosphate (LFP) battery that contains organic electrolyte and is sealed in a protective case. Leaked electrolyte is toxic and highly flammable. Leaked electrolyte is colorless and has a sweet odor. Electrolyte fluid tends to evaporate quickly, leaving behind a white grainy substance. If an odor is obvious, proceed to the following steps:



DANGER: DO NOT TOUCH OR INGEST ANY LIQUID SUSPECTED TO BE BATTERY ELECTROLYTE.

- Evacuate personnel to a safe area and keep unauthorized personnel away.
- Isolate spill area to a minimum distance of 75 feet (25 m).
- Eliminate all ignition sources (no smoking, sparks, flames, hot equipment) in the immediate area around the spill.
- Do not touch or walk through spilled material.
- Avoid breathing vapors. Ensure adequate ventilation.
- Use personal protective equipment.
- Contact Enphase Customer Support at <https://enphase.com/contact/support> or 1800 006 374

Safety and Advisory Symbols



DANGER: This indicates a hazardous situation, which if not avoided, will result in death or serious injury.



WARNING: This indicates a situation where failure to follow instructions may be a safety hazard or cause equipment malfunction. Use extreme caution and follow instructions carefully.



NOTE: This indicates information particularly important for optimal system

operation. Follow instructions carefully.



Safety Instructions



DANGER: Risk of electric shock. Risk of fire. Only qualified electricians should install, troubleshoot, or replace the IQ Battery(ies).



DANGER: Risk of fire or explosion. Only qualified personnel, using personal protective equipment (PPE) should transport or handle the IQ Battery(ies).



DANGER: Risk of explosion. Do not dispose of IQ Battery(ies) in a fire or by burning. The IQ Battery(ies) can explode.

DANGER: Risk of fire or explosion. This product is designed for stationary installation only and should be used accordingly. It is not designed for mobile applications such as installation and on vehicles and trailers and should not be used in such applications.



DANGER: Risk of fire. During use, when stored, or during transport, keep the IQ Battery(ies) in an area that is well ventilated and protected from the elements, where the ambient temperature and humidity are within -20° C to 55° C (-4° F to 131° F) and 5% to 95% RH, non-condensing, preferably out of direct sunlight. Do not install the IQ Battery(ies) at elevations over 2000 m (6561 ft) above sea level.



DANGER: Risk of fire. If the IQ Battery(ies) generate smoke, remove AC power from the Enphase System and turn the DC control switch to the off position so that charging/discharging stops.



DANGER: Risk of electric shock. Do not use Enphase equipment in a manner not specified by the manufacturer. Doing so may cause death or injury to persons, or damage to equipment.



DANGER: Risk of electric shock. Do not install the IQ Battery(ies) without first removing AC power from the photovoltaic system. Disconnect the power coming from the photovoltaics before servicing or installing.



DANGER: Risk of electric shock. Always de-energize the AC branch circuit during an emergency and/or before servicing the IQ Battery(ies).



DANGER: Risk of electric shock. Risk of high short-circuit current. Observe the following precautions when working on batteries:

- Remove watches, rings, or other metal objects.
- Use tools with insulated handles.
- Wear insulating gloves and boots.
- Do not lay tools or metal parts on top of batteries.



DANGER: Risk of electric shock. Risk of fire. Do not work alone. Someone should be in the range of your voice or close enough to come to your aid when you work with or near electrical equipment.



DANGER: Risk of fire. Do not allow or place flammable, sparking, or explosive items near the IQ Battery(ies).



DANGER: Risk of electric shock. In areas where flooding is possible, install the IQ Battery(ies) at a height that prevents water ingress.



DANGER: Risk of electric shock. AC voltage is present at the output when the DC switch is on.





DANGER: Risk of electric shock. Branch circuit protection must be off before switching DC power on or off.





DANGER: Risk of electric shock. The DC switch must be in the OFF position for shipping and service.





 **WARNING:** Risks of electric shock, energy hazard, and chemical hazard. Do not disassemble.

 **WARNING:** Risk of equipment damage. During use, storage, transport, or installation, always keep the IQ Battery(ies) in an upright position.

 **WARNING:** You must install the IQ Battery(ies) only on a suitable wall using an Enphase wall-mount bracket.

 **WARNING:** Before installing or using the IQ Battery(ies), read all instructions and cautionary markings in this guide and on the equipment.

 **WARNING:** Do not install or use the IQ Battery(ies) if it has been damaged in any way.

 **WARNING:** Do not exceed the maximum number (1) of IQ Batteries in a 20 A AC branch circuit.

 **WARNING:** Do not sit on, step on, place objects on, or insert objects into the IQ Battery(ies).

 **WARNING:** Do not place beverages or liquid containers on top of the IQ Battery(ies). Do not expose the IQ Battery(ies) to liquids or flooding.

WARNING: When placing the IQ Battery(ies) in storage, ensure to follow the shutdown procedure and confirm that AC power is not present and that the DC switch is in the OFF position. While in storage, damage to the battery can occur from over-discharge. If the battery state of charge falls to 0%, the IQ Battery(ies) can be damaged or destroyed. Because of this, the IQ Battery(ies) must only be stored for a limited amount of time.

- The IQ Battery(ies) must be installed and energized by the “Must Energize By” date on the shipping box label.
- The IQ Battery(ies) must have a charge state of no more than 30% when placed in storage. To do this, the IQ Battery(ies) must be placed in Sleep Mode.
- If the IQ Battery(ies) is already been installed, it must be placed into Sleep Mode prior to uninstalling. A battery in Sleep Mode can be stored a maximum of two months after being placed into Sleep Mode.



NOTE: Perform installation and wiring, including protection against lightning and resulting voltage surge, in accordance with all applicable local electrical codes and standards.



 **NOTE:** Using unapproved attachments or accessories could result in damage or injury.

 **NOTE:** Install properly rated over current protection as part of the system installation.



NOTE: To ensure optimal reliability and to meet warranty requirements, the IQ Battery(ies) must be installed and/or stored according to the instructions in this guide.



NOTE: The Enphase IQ Battery(ies) are intended to operate with an Internet connection. Failure to maintain an Internet connection may have an impact on the warranty. See Limited Warranty for full terms and services (enphase.com/warranty).



NOTE: When replacing Enphase IQ Battery(ies), you must replace with an IQ Battery(ies) of the same type, with the same AC current rating.



NOTE: When disconnected and stored, no automatic charge of the battery is possible.



NOTE: Properly mount the IQ Battery(ies). Ensure that the mounting location is structurally suited to bearing the weight of the IQ Battery(ies).

NOTE: During use, storage, and transport, keep the IQ Battery(ies):

- Properly ventilated
- Away from water, other liquids, heat, sparks, and direct sunlight
- Away from excessive dust, corrosive and explosive gases like ammonia, and oil smoke
- Away from direct exposure to gas exhaust, such as from motor vehicles
- Free of vibrations
- Away from falling or moving objects, including motor vehicles. If mounted in the path of a motor vehicle, we recommend a 91 cm (36 in) minimum mounting height
- At an elevation of lower than 2,000 m (6561 ft) above sea-level
- In a location compliant with fire safety regulations
- In a location compliant with local building codes and standards



NOTE: Conditions for the IQ Battery 5P installation site apply also to storage conditions.

Manufacturer:
Enphase Energy Inc.,
47281 Bayside Pkwy.,
Fremont, CA, 94538,
The United States of America
PH: +1 707-763-4784
Assembled in China

Importer:
Enphase Energy Aust.
Pty/Ltd., 88 Market St.,
South Melbourne VIC 3205.
PH: +61 3 86691679

Enphase Customer Support: <https://enphase.com/contact/support>



Environmental Protection

ELECTRONIC DEVICE: DO NOT THROW AWAY. Waste electrical products should not be disposed of with household waste.

Proper disposal of batteries is required. Refer to your local codes for disposal requirements

Installer notes

Installer notes

Installer notes

© 2023 Enphase Energy. All rights reserved. Enphase, the e and CC logos, IQ, and certain other marks listed at <https://enphase.com/trademark-usage-guidelines> are trademarks of Enphase Energy, Inc. in the US and other countries. Data subject to change.

