

SWIMMING POOL HEAT PUMP UNIT

Installation & Instruction Manual

CONTENTS

1. Preface	1
2. Specifications	2
2.1 Performance Data of Swimming Pool Heat Pump Unit	2
2.2 Dimensions for Swimming Pool Heat Pump Unit	4
2.3 How to separate and install the electric box cover	6
3. Installation and Connection	7
3.1 Installation of System	7
3.2 Swimming Pool Heat Pumps Location	8
3.3 How Close to Your Pool?	9
3.4 Swimming Pool Heat Pumps Plumbing	10
3.5 Swimming Pool Heat Pumps Electrical Wiring	10
3.6 Initial Start-up of the Unit	10
4. Use and Operation Instruction of Wire Controller	11
4.1 Interface display	11
4.2 Key and icon function instruction	13
4.3 Startup & shutdown	13
4.4 Mode switch	13
4.5 Temperature setting	14
4.6 Clock setting	15
4.7 Silent setting	17
4.8 Keyboard lock	18
4.9 Fault interface	18
4.10 Parameter list and breakdown table	19
5. Maintenance and Inspection	22
6. Appendix	23

1. PREFACE

- In order to provide our customers with quality, reliability and versatility, this product has been made to strict production standards. This manual includes all the necessary information about installation, debugging, discharging and maintenance. Please read this manual carefully before you open or maintain the unit. The manufacture of this product will not be held responsible if someone is injured or the unit is damaged, as a result of improper installation, debugging, or unnecessary maintenance. It is vital that the instructions within this manual are adhered to at all times. The unit must be installed by qualified personnel.
- The unit can only be repaired by qualified installer centre, personnel or an authorised dealer.
- Maintenance and operation must be carried out according to the recommended time and frequency, as stated in this manual.
- Use genuine standard spare parts only.
Failure to comply with these recommendations will invalidate the warranty.
- Swimming Pool Heat Pump Unit heats the swimming pool water and keeps the temperature constant. For split type unit, The indoor unit can be Discretely hidden or semi-hidden to suit a luxury house.

Our heat pump has following characteristics:

1 Durable

The heat exchanger is made of PVC & Titanium tube which can withstand prolonged exposure to swimming pool water.

2 Installation flexibility

The unit can be installed outdoors or indoors.

3 Quiet operation

The unit comprises an efficient rotary/ scroll compressor and a low-noise fan motor, which guarantees its quiet operation.

4 Advanced controlling

The unit includes micro-computer controlling, allowing all operation parameters to be set. Operation status can be displayed on the LCD wire controller. Remote controller can be chosen as future option.

2.SPECIFICATION

2.1 Performance data of Swimming Pool Heat Pump Unit

*** REFRIGERANT : R410A

UNIT		PASRW015-P-AE	PASRW020-P-AE
Heating capacity (27/24.3℃)	kW	5.95	8.47
	Btu/h	20230	28798
Heating Power Input	kW	1.04	1.45
Running Current	A	4.8	6.5
Heating capacity (24/19℃)	kW	5.36	7.74
	Btu/h	18224	26316
Heating Power Input	kW	1.05	1.48
Running Current	A	4.9	6.6
Heating capacity (15/12℃)	kW	4.25	6.01
	Btu/h	14450	20434
Heating Power Input	kW	1.0	1.4
Running Current	A	4.6	6.3
Power Supply		220-240V~/50Hz	220-240V~/50Hz
Compressor Quantity		1	1
Compressor		rotary	rotary
Fan Number		1	1
Fan Power Input	W	90	90
Fan Rotate Speed	RPM	850	850
Fan Direction		horizontal	horizontal
Noise	dB(A)	50	52
Water Connection	mm	50	50
Water Flow Volume	m ³ /h	2.3	3
Water Pressure Drop(max)	kPa	2.4	3.2
Unit Net Dimensions(L/W/H)	mm	See the drawing of the units	
Unit Ship Dimensions(L/W/H)	mm	See package lable	
Net Weight	kg	see nameplate	
Shipping Weight	kg	see package label	

Heating: Outdoor air temp: 27℃/24.3℃, Inlet water temp:26℃

Outdoor air temp: 24℃/19℃, Inlet water temp:26℃

Outdoor air temp: 15℃/12℃, Inlet water temp:26℃

2.SPECIFICATION

2.1 Performance data of Swimming Pool Heat Pump Unit

*** REFRIGERANT : R410A

UNIT		PASRW030-P-AE	PASRW040-P-AE
Heating capacity (27/24.3℃)	kW	11.6	16.3
	Btu/h	39440	55420
Heating Power Input	kW	1.98	2.94
Running Current	A	9.1	13.5
Heating capacity (24/19℃)	kW	10	15.5
	Btu/h	34000	52700
Heating Power Input	kW	1.90	2.90
Running Current	A	8.7	13.3
Heating capacity (15/12℃)	kW	8.0	12.8
	Btu/h	27200	43520
Heating Power Input	kW	1.8	2.88
Running Current	A	8.2	13.2
Power Supply		220-240V~/50Hz	220-240V/50Hz
Compressor Quantity		1	1
Compressor		rotary	Rotary
Fan Number		1	1
Fan Power Input	W	120	150
Fan Rotate Speed	RPM	850	850
Fan Direction		horizontal	Horizontal
Noise	dB(A)	54	56
Water Connection	mm	50	50
Water Flow Volume	m ³ /h	4.5	5.0
Water Pressure Drop(max)	kPa	3.5	4.2
Unit Net Dimensions(L/W/H)	mm	See the drawing of the units	
Unit Ship Dimensions(L/W/H)	mm	See package lable	
Net Weight	kg	see nameplate	
Shipping Weight	kg	see package label	

Heating: Outdoor air temp: 27℃/24.3℃, Inlet water temp:26℃

Outdoor air temp: 24℃/19℃, Inlet water temp:26℃

Outdoor air temp: 15℃/12℃, Inlet water temp:26℃

2.SPECIFICATION

2.2 Dimensions for Swimming Pool Heat Pump Unit

PASRW015-P-AE

unit: mm

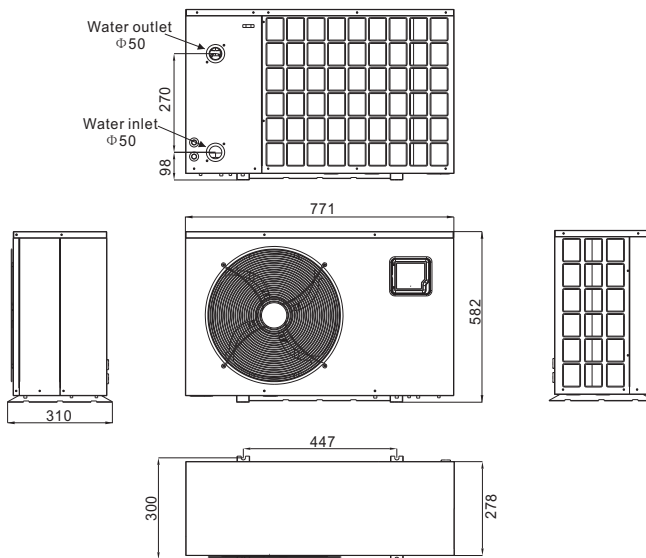

PASRW020-P-AE
PASRW030-P-AE

unit: mm

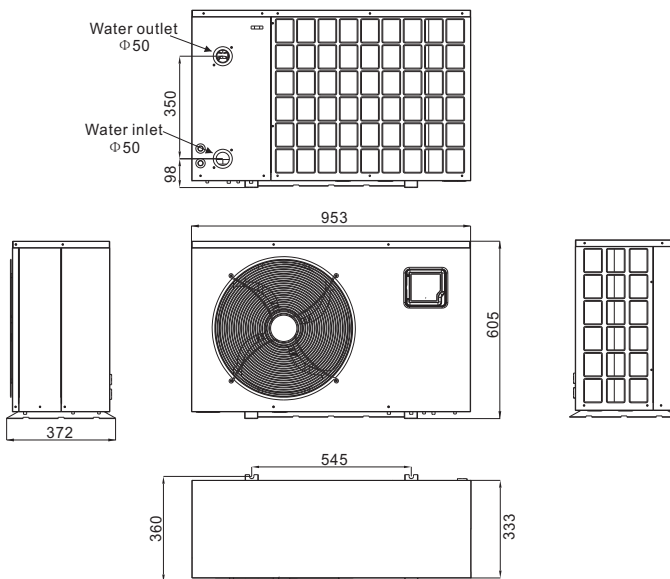

2.SPECIFICATION

PASRW040-P-AE

unit: mm

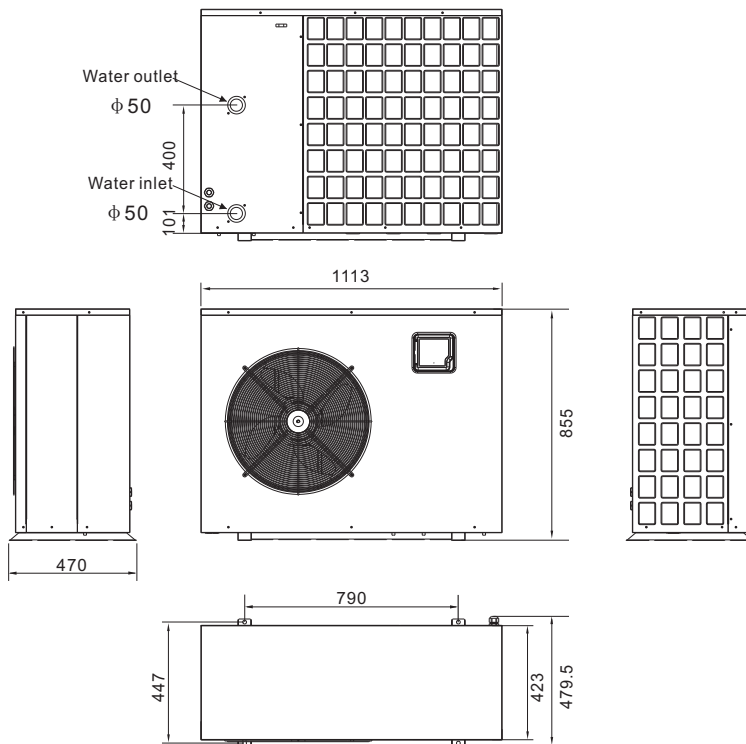

2.SPECIFICATION

2.3 How to separate and install the electric box cover

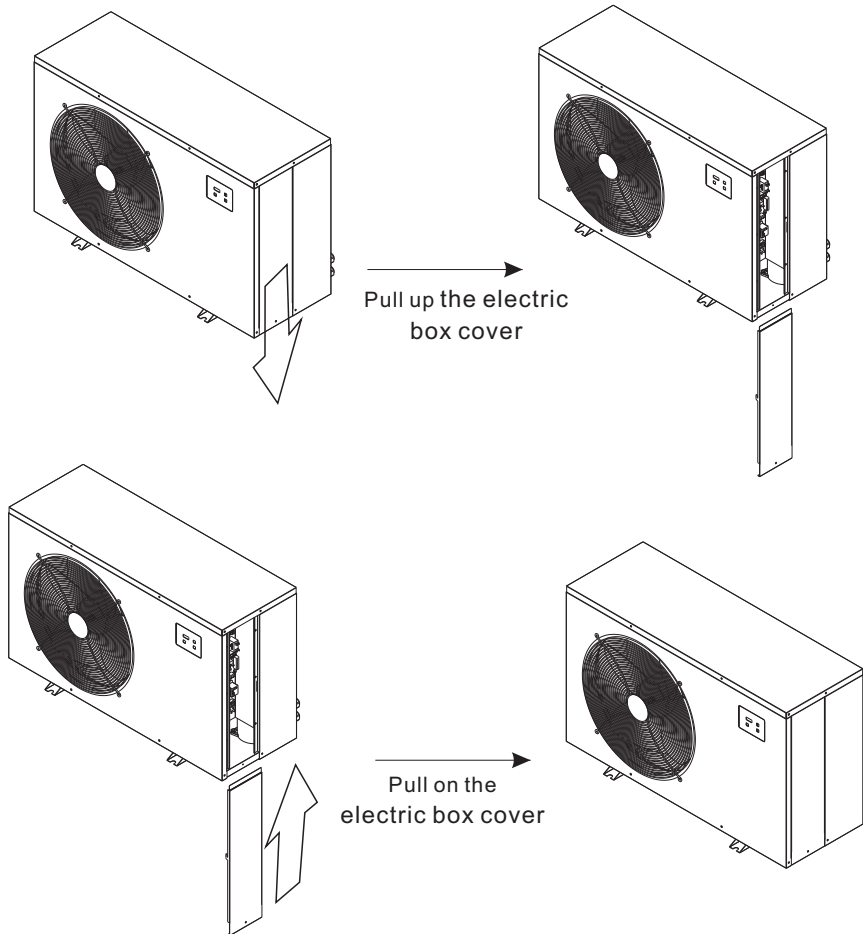

Attention: 1. Please be careful when handle with the electric box cover in case of damage;
2. During installation to buckle matched with the clamping groove of the electric box cover, so that it can cover the electric box cover.

3.INSTALLATION AND CONNECTION

3.1 Installation illustration

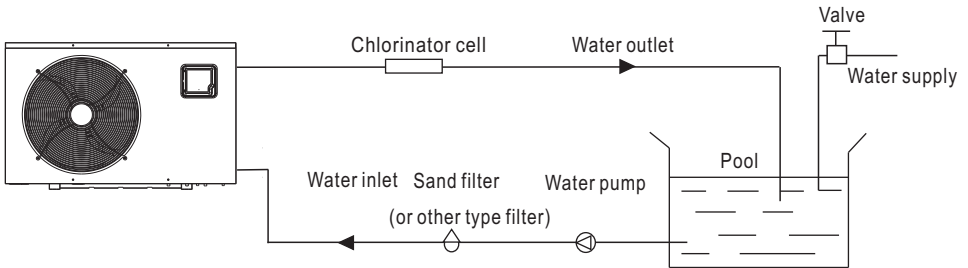

Installation items:

The factory only provides the main unit and the water unit; the other items in the illustration are necessary spare parts for the water system, that provided by users or the installer.

Attention:

Please follow these steps when using for the first time

1. Open valve and charge water.
2. Make sure that the pump and the water-in pipe have been filled with water.
3. Close the valve and start the unit.

ATTN: It is necessary that the water-in pipe is higher than the pool surface.

The schematic diagram is for reference only. Please check the water inlet/outlet label on the heat pump while plumbing installation.

3.INSTALLATION AND CONNECTION

3.2 Swimming Pool Heat Pumps Location

The unit will perform well in any outdoor location provided that the following three factors are presented:

1. Fresh Air -
2. Electricity -
3. Pool filter piping

The unit may be installed virtually anywhere outdoors. For indoor pools please consult the supplier. Unlike a gas heater, it has no draft or pilot light problem in a windy area.

DO NOT place the unit in an enclosed area with a limited air volume, where the units discharge air will be re-circulated.

DO NOT place the unit to shrubs which can block air inlet. These locations deny the unit of a continuous source of fresh air which reduces it efficiency and may prevent adequate heat delivery.

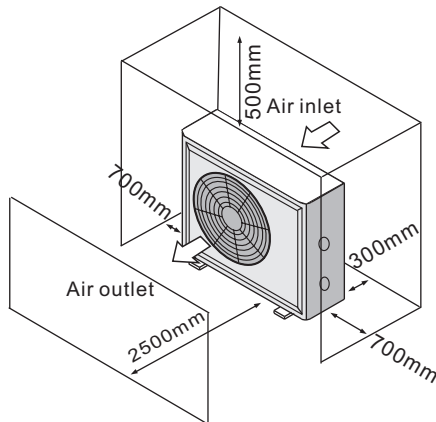

3.3 How Close To Your Pool?

Normally, the pool heat pump is installed within 7.5 metres of the pool. The longer the distance from the pool, the greater the heat loss from the piping. For the most part, the piping is buried. Therefore, the heat loss is minimal for runs of up to 15 meters (15 meters to and from the pump = 30 meters total), unless the ground is wet or the water table is high. A very rough estimate of heat loss per 30 meters is 0.6 kW-hour, (2000BTU) for every 5 °C difference in temperature between the pool water and the ground surrounding the pipe, which translates to about 3% to 5% increase in run time.

3.INSTALLATION AND CONNECTION

3.4 Swimming Pool Heat Pumps Plumbing

The Swimming Pool Heat Pumps exclusive rated flow titanium heat exchanger requires no special plumbing arrangements except bypass(please set the flow rate according to the nameplate). The water pressure drop is less than 10kPa at max. Flow rate. Since there is no residual heat or flame Temperatures, The unit does not need copper heat sink piping. PVC pipe can be run straight into the unit.

Location: Connect the unit in the pool pump discharge (return) line downstream of all filter and pool pumps, and upstream of any chlorinators, ozonators or chemical pumps.

Standard model have slip glue fittings which accept 32mm or 50 mm PVC pipe for connection to the pool or spa filtration piping. By using a 50 NB to 40NB you can plumb 40NB

Give serious consideration to adding a quick coupler fitting at the unit inlet and outlet to allow easy draining of unit for winterizing and to provide easier access should servicing be required.

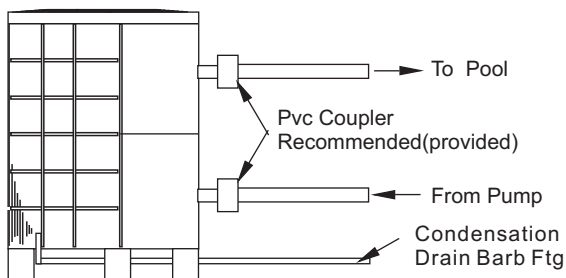

Condensation: Since the Heat pump cools down the air about 4 -5°C, water may condense on the fins of the horseshoe shaped evaporator. If the relative humidity is very high, this could be as much as several litres an hour. The water will run down the fins into the basepan and drain out through the barbed plastic condensation drain fitting on the side of the basepan. This fitting is designed to accept 20mm clear vinyl tubing which can be pushed on by hand and run to a suitable drain. It is easy to mistake the condensation for a water leak inside the unit.

NB: A quick way to verify that the water is condensation is to shut off the unit and keep the pool pump running. If the water stops running out of the basepan, it is condensation. AN EVEN QUICKER WAY IS to TEST THE DRAIN WATER FOR CHLORINE - if there is no chlorine present, then it's condensation.

3. INSTALLATION AND CONNECTION

3.5 Swimming Pool Heat Pumps Electrical Wiring

NOTE: Although the unit heat exchanger is electrically isolated from the rest of the unit, it simply prevents the flow of electricity to or from the pool water. Grounding the unit is still required to protect you against short circuits inside the unit. Bonding is also required.

The unit has a separate molded-in junction box with a standard electrical conduit nipple already in place. Just remove the screws and the front panel, feed your supply lines in through the conduit nipple and wire-nut the electric supply wires to the three connections already in the junction box (four connections if three phase). To complete electrical hookup, connect Heat Pump by electrical conduit, UF cable or other suitable means as specified (as permitted by local electrical authorities) to a dedicated AC power supply branch circuit equipped with the proper circuit breaker, disconnect or time delay fuse protection.

Disconnect - A disconnect means (circuit breaker, fused or un-fused switch) should be located within sight of and readily accessible from the unit. This is common practice on commercial and residential air conditioners and heat pumps. It prevents remotely-energizing unattended equipment and permits turning off power at the unit while the unit is being serviced.

3.6 Initial startup of the Unit

NOTE- In order for the unit to heat the pool or spa, the filter pump must be running to circulate water through the heat exchanger.

Start up Procedure - After installation is completed, you should follow these steps:

1. Turn on your filter pump. Check for water leaks and verify flow to and from the pool.
2. Turn on the electrical power supply to the unit, then press the key ON/OFF of wire controller. It should start in several seconds.
3. After running a few minutes make sure the air leaving the top(side) of the unit is cooler (Between 5-10 °C)
4. With the unit operating turn the filter pump off. The unit should also turn off automatically.
5. Allow the unit and pool pump to run 24 hours per day until desired pool water temperature is reached. When the water-in temperature reach setting, The unit just shuts off. The unit will now automatically restart (as long as your pool pump is running) when the pool temperature drops more than 2°C below set temperature.

Time Delay- The unit is equipped with a 3 minute built-in solid state restart delay included to protect control circuit components and to eliminate restart cycling and contactor chatter. This time delay will automatically restart the unit approximately 3 minutes after each control circuit interruption. Even a brief power interruption will activate the solid state 3 minute restart delay and prevent the unit from starting until the 5 minute countdown is completed. Power interruptions during the delay period will have no effect on the 3 minute countdown.







4. Use and Operation Instruction of Wire Controller

1. Interface display

























2. Key and icon function instruction

2.1 Key function instruction

Key symbols	Designation	Function
	Mute key	Under the heating mode or heating mode under the automatic mode, the mute key operation is effective and used to enter and exit the mute mode with one click.
	Mode key	It is used to switch the unit mode, temperature setting, and parameter setting.
	On-off key	It is used to carry out startup & shutdown, cancel current operation, and return to the last level of operation.
	Up key	It is used to page up, and increase variable value.
	Down key	It is used to page down, and decrease variable value.
	Clock key	It is used as user clock, and to carry out timing setting.

4. Use and Operation Instruction of Wire Controller

2.2. Icon function instruction

Icon symbol	Designation	Function
	Cooling symbol	It will display during cooling (there is no limit to startup & shutdown, and it is optional when the unit is cooling-only unit or heating-and-cooling unit).
	Heating symbol	It will display during heating (there is no limit to startup & shutdown, and it is optional when the unit is heating-only unit or heating-and-cooling unit).
	Automatic symbol	It will display under the automatic mode (there is no limit to startup & shutdown, and it is optional when the unit is heating-and-cooling unit).
	Defrosting symbol	It will display in the defrosting process of the unit.
	Compressor symbol	It will display when compressor is started.
	Water pump symbol	It will display when water pump is started.
	Fan symbol	It will display when fan is started.
	Mute symbol	When the timing mute function is started, it keeps bright for a long time. When it is in mute state, it will flash. Or else, it is off.
	Timing symbol	It will display after the user sets the timing, and multiple timing intervals can be set .
	Water outlet symbol	When the axillary display area displays the water outlet temperature, the light is on.
	Water inlet symbol	When the main display area displays the water inlet temperature, the light is on.
	Locking key symbol	When the keyboard is locked, it is on.
	Fault symbol	In case of unit fault, it is on.
	Wireless signal symbol	When the unit is connected to WIFI module, it will display according to the strength of WIFI signal.
	Degrees Celsius symbol	When main display area or auxiliary display area displays degrees Celsius, it is on.
	Degrees Fahrenheit symbol	When main display area or auxiliary display area displays degrees Fahrenheit, it is on.
	Setting symbol	When the parameter is adjustable, it is on
	Second symbol	When main display area displays second digit, it is on.
	Minute symbol	When main display area displays minute digit, it is on.
	Hour symbol	When main display area displays hour digit, it is on.
	Pressure symbol	When main display area displays pressure, it is on.
	Flow symbol	When main display area displays flow, it is on.

4. Use and Operation Instruction of Wire Controller

3. Startup & shutdown

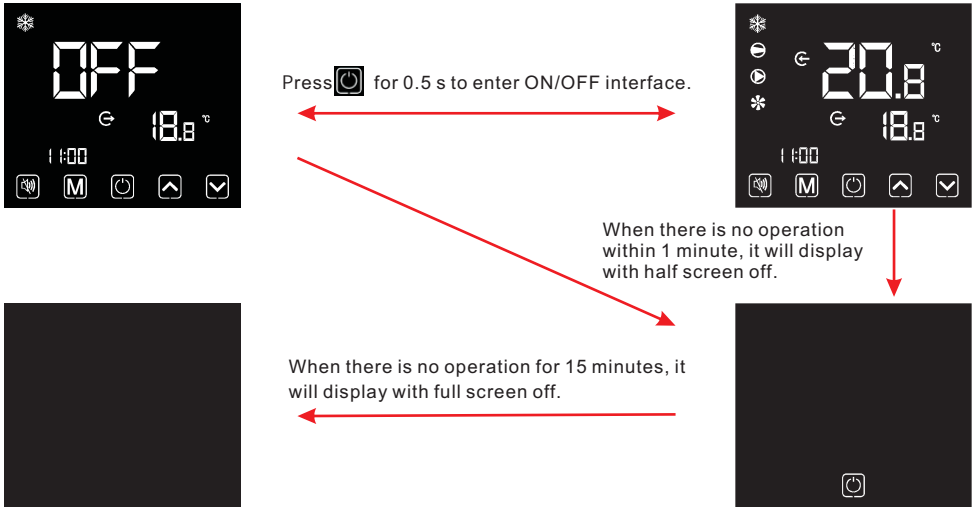

Notes:

Startup & shutdown operation can only be conducted in the main interface.

When it displays with half screen off or full screen off, click any key for returning to ON/OFF main interface.

When the unit is started under the control of wire controller, if using the emergency switch to shut down, the wire controller will display as follows:

Operations are the same as under ON/OFF main interface.



4. Mode switch

Under the main interface, Short press  to switch the unit among cooling, heating and automatic mode.

4. Use and Operation Instruction of Wire Controller

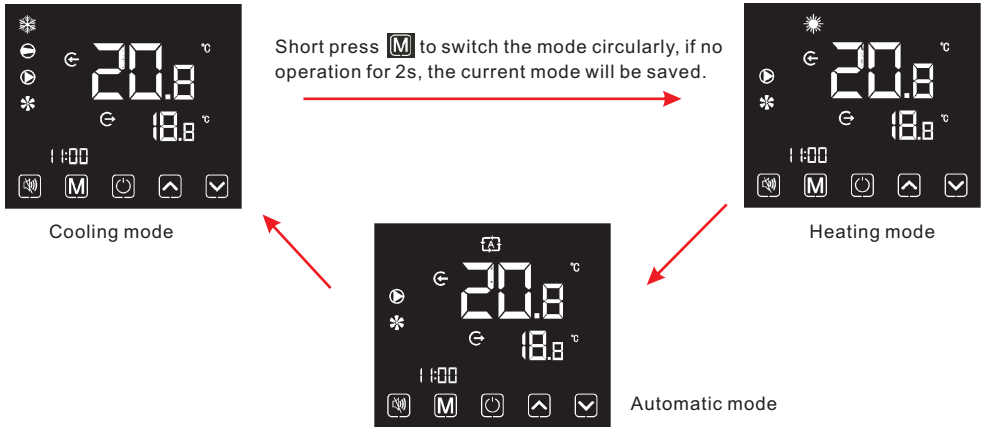

Operation descriptions:

- 1). Mode switch operation can only be conducted in the main interface.
- 2). When the unit is under the defrosting state, the defrosting symbol is on, with the display interface as follows:

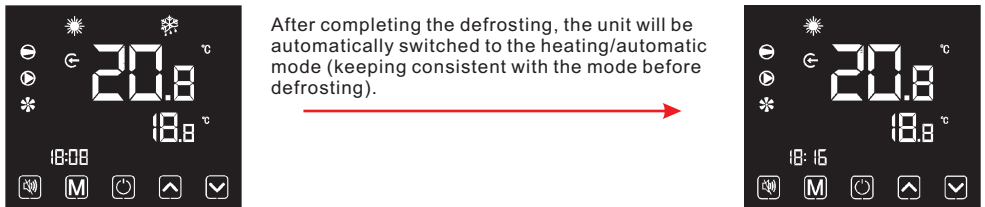

Notes: During the defrosting, mode switch is available. And when switching the mode, the unit won't work under a new mode until defrosting is completed.

5. Temperature setting

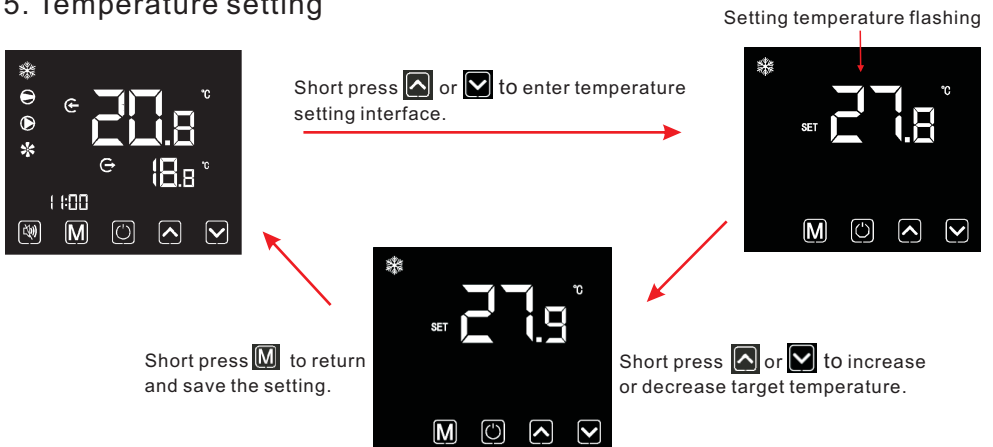

4. Use and Operation Instruction of Wire Controller

Notes: Under the temperature setting interface, if short press  , the system will return to the main interface without any changes saved; If there is no operation for 5 s, the system will automatically memorize user's setting, and return to the main interface.

6. Clock setting

6.1 System time setting

1). Permanent awakening clock key

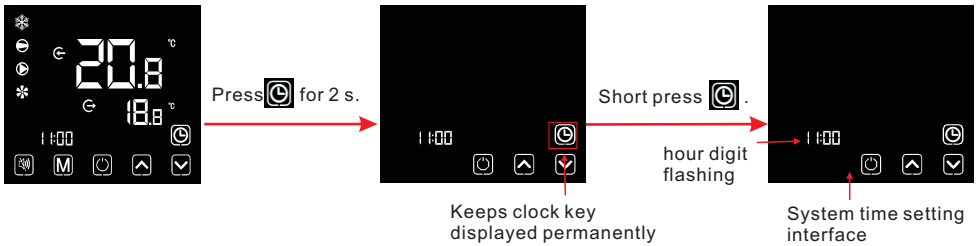

2). Single awakening clock key

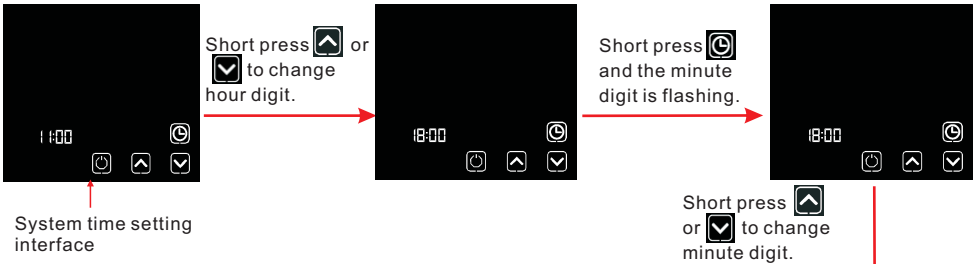

3). System time setting

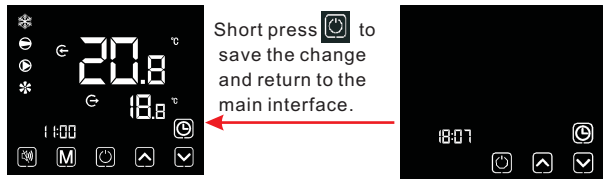

Notes: After the permanent awakening of clock key, if it is not cancelled by user, the main interface will display the clock key permanently. Under the clock setting interface, if short press  , the change will not be saved and return to the main interface; if there is no operation for 20s, the system will automatically memorize user's setting, and return to the main interface.

4. Use and Operation Instruction of Wire Controller

6.2 Setting and cancellation of timing ON and OFF

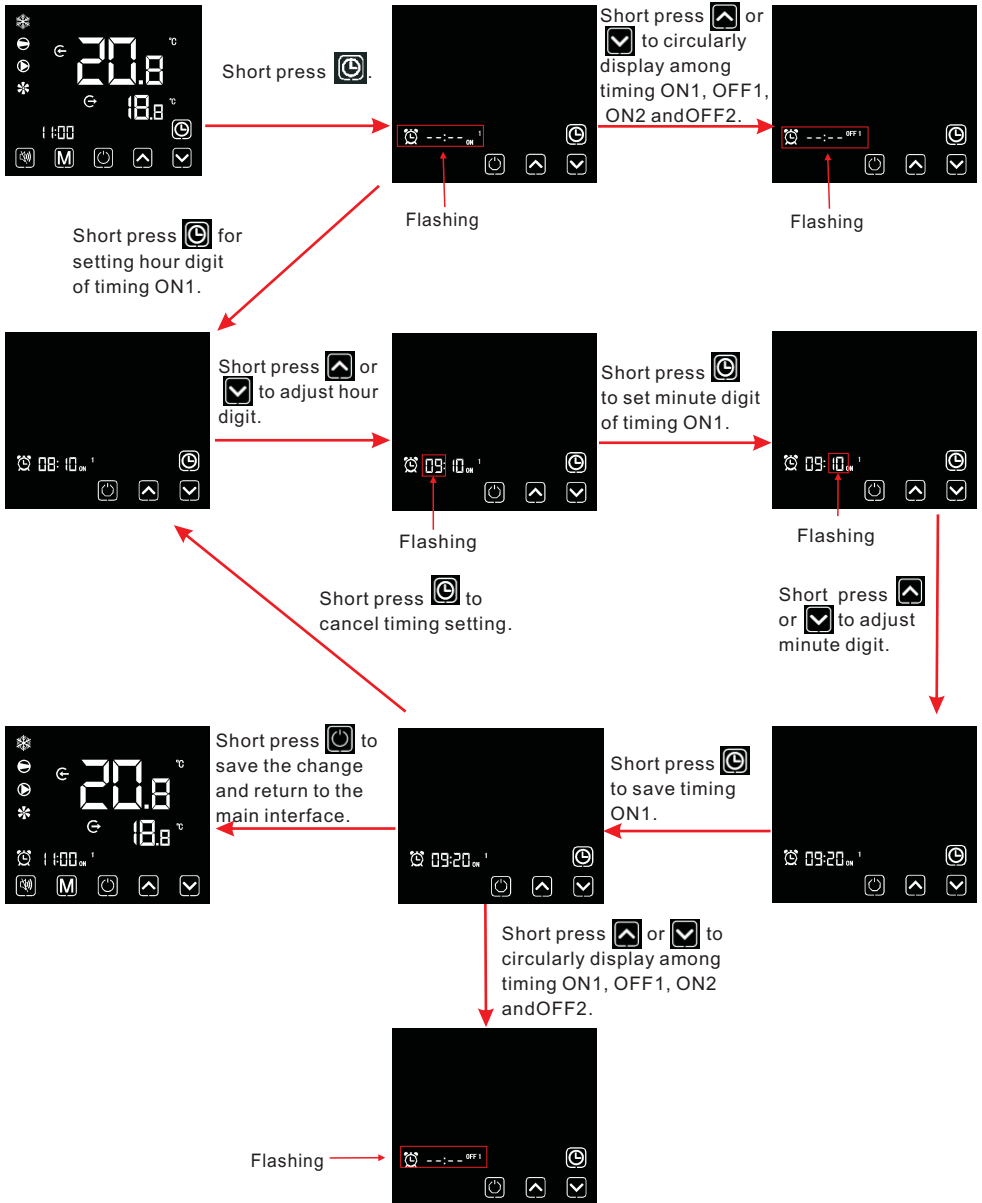

Notes: If there is no operation for 20 s, the system will automatically memorize user's setting, and return to the main interface; If the timing symbol and entire time digits flash at the same time, click [Power icon] for returning to the main interface.

4. Use and Operation Instruction of Wire Controller

7. Mute setting

7.1 One-click mute



Notes:



- 1). If one-click mute and timing mute are started at the same time, short press  to cancel one-click mute and quitting the timing mute for this time.
- 2). At night or the rest time, user can start one-click mute or timing mute function to reduce the noise.

7.2 Setting and cancellation of timing mute



4. Use and Operation Instruction of Wire Controller

Notes:

- 1). When the mute icon  is lightened: The timing mute has been set, but it's not under mute status.
- 2). When the mute icon  flash: It's under the mute status.
- 3). When the mute icon  disappear: The timing mute is not set.

8. Keyboard lock

To avoid others' misoperation, please lock the wire controller after completing the setting.



Notes:

- 1). Under the locked screen interface, only unlocking operation is available, and the screen will be lightened after other operations conducted.
- 2). Under the OFF interface, locking operation is available, and the operation method is the same as locking screen under the ON interface.

9. Fault interface

When the unit fails, the wire controller can display the corresponding code according to the fault reason. Refer to the fault table for the specific definition of the fault codes.

For example:

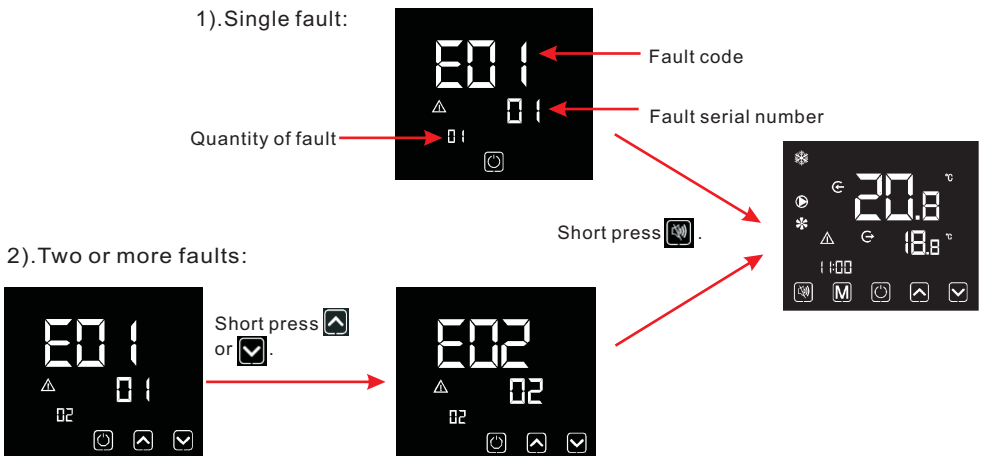

Remark:

the wire controller can display the temperature unit as "°F" or "°C" according to the unit model you bought.

4. Use and Operation Instruction of Wire Controller

10 . Parameter list and breakdown table

10.1 Electronic control fault table

Can be judged according to the remote controller failure code and troubleshooting

Protect/fault	Fault display	Reason	Elimination methods
Inlet Temp. Sensor Fault	P01	The temp. sensor is broken or short circuit	Check or change the temp. sensor
Outlet Temp. Sensor Fault	P02	The temp. sensor is broken or short circuit	Check or change the temp. sensor
Ambient Temp. Sensor Fault	P04	The temp. sensor is broken or short circuit	Check or change the temp. sensor
Coil 1 Temp. Sensor Fault	P05	The temp. sensor is broken or short circuit	Check or change the temp. sensor
Coil 2 Temp. Sensor Fault	P15	The temp. sensor is broken or short circuit	Check or change the temp. sensor
Suction Temp. Sensor Fault	P07	The temp. sensor is broken or short circuit	Check or change the temp. sensor
Exhaust Temp. Sensor Fault	P081	The temp. sensor is broken or short circuit	Check or change the temp. sensor
Exhaust Air Over-Temp Prot.	P082	The compressor is overload	Check whether the compressor running normally
Antifreeze Temp. Sensor Fault	P09	The temp. sensor is broken or short circuit	Check or change the temp. sensor
Pressure Sensor Fault	PP	The pressure sensor is broken	Check or change the pressure sensor or pressure
High Pressure Prot.	E01	The high-pressure switch is broken	Check the pressure switch and cold circuit
Low Pressure Prot.	E02	The low-pressure switch is broken	Check the pressure switch and cold circuit
Flow Switch Prot.	E03	The temp. sensor is broken or short circuit	Check or change the temp. sensor
Waterway Anti-freezing Prot.	E05	No water/little water in water system	Check the pipe water flow and water pump
Excess Water In/Out Temp. Diff. Prot.	E06	Water flow is not enough and low differential pressure	Check the pipe water flow and whether water system is jammed or not
Anti-freezing Prot.	E07	Water flow is not enough	Check the pipe water flow and whether water system is jammed or not
Primary Anti-freezing Prot.	E19	The ambient temp. is low	Check whether the ambient temp. is low or not
Secondary Anti-freezing Prot.	E29	The ambient temp. is low	Check whether the ambient temp. is low or not
Comp. Overcurrent Prot.	E051	The compressor is overload	Check whether the system of the compressor running normally
Communication Fault	E08	Communication failure between wire controller and mainboard	Check the wire connection between remote wire controller and main board
Comm. Fault(Mainboard-DC Fan)	E081	Speed control module and main board communication fail	Check the communication connection
Low AT Prot.	TP	The ambient temp. is low	Check whether the ambient temp. is low or not
EC fan feedback Fault	F051	There is something wrong with fan motor and fan motor stops running	Check whether fan motor is broken or locked or not
Fan Motor1 Fault	F031	1. Motor is in locked-rotor state 2.The wire connection between DC-fan motor module and fan motor is in bad contact	1.Change a new fan motor 2.Check the wire connection and make sure they are in good contact

4. Use and Operation Instruction of Wire Controller

Fan Motor 2 Fault	F032	1. Motor is in locked-rotor state 2. The wire connection between DC-fan motor module and fan motor is in bad contact	1. Change a new fan motor 2. Check the wire connection and make sure they are in good contact
-------------------	------	---	--

Frequency conversion board fault table:

Protect/fault	Fault display	Reason	Elimination methods
Driver MOP Alarm	F01	MOP drive alarm	Recovery after the 150s
Inverter Board Offline	F02	Frequency conversion board and main board communication failure	Check the communication connection
IPM protection	F03	IPM modular protection	Recovery after the 150s
Comp. Driver Failure	F04	Lack of phase, step or drive hardware damage	Check the measuring voltage check frequency conversion board hardware
DC Fan Fault	F05	Motor current feedback open circuit or short circuit	Check the input voltage measurement
IPM Input Overcurrent Prot.	F06	IPM input current is too large	Check and adjust the current measurement
Inv. DC Over-volt.	F07	DC bus voltage > Dc bus Overload-voltage protection value	Check the input voltage measurement
Inv. DC Under-volt.	F08	DC bus voltage < Dc bus Underload-voltage protection value	Check the input voltage measurement
Inv. Input Under-volt.	F09	The input voltage is low, causing the input current is low	Check the input voltage measurement
Inv. Input Over-volt.	F10	The input voltage is too high, more than outage protection current RMS	Check the input voltage measurement
Inv. Sampling Volt. Fault	F11	The input voltage sampling fault	Check and adjust the current measurement
Comm. Err DSP-PFC	F12	DSP and PFC connect fault	Check the communication connection
Input Over Cur.	F26	The equipment load is too large	Check the input current of the unit whether is bigger than the rate current
PFC fault	F27	The PFC circuit protection	Check the PFC switch tube short circuit or not
IPM Superheat Prot.	F15	The IPM module is overheat	Check and adjust the current measurement
Weak Magnetic Warn	F16	Compressor magnetic force is not enough	Restart the unit after multiple power failures, if the fault still exists, replace the compressor
Inv. Input Out of Phase	F17	The input voltage lost phase	Check and measure the voltage adjustment
IPM Sampling Current Fault	F18	IPM sampling electricity is fault	Check and adjust the current measurement
Inv. Temp. Probe Fault	F19	Sensor is short circuit or open circuit	Inspect and replace the sensor
Inverter Superheat Prot.	F20	The transducer is overheat	Check and adjust the current measurement
Inverter Superheat Warn	F22	Transducer temperature is too high	Check and adjust the current measurement
Comp. Over Cur. Warn	F23	Compressor is too large	Check and adjust the current measurement
Input Over Cur. Warn	F24	Input current is too large	Check and adjust the current measurement
EEPROM Error Warn	F25	MCU error	Check whether the chip is damaged Replace the chip
V15V Over/Under-Volt. Prot.	F28	The V15V is overload or undervoltage	Check the V15V input voltage in range 13.5v~16.5v or not

4. Use and Operation Instruction of Wire Controller

10.2 Parameter list

Meaning	Default	Remarks
Refrigeration target temperature set point	27°C	Adjustable
Heating the target temperature set point	27°C	Adjustable
Automatic target temperature set point	27°C	Adjustable

5. MAINTENANCE AND INSPECTION

- Check the water supply device and the release often. You should avoid the condition of no water or air entering into system, as this will influence unit's performance and reliability. You should clear the pool/spa filter regularly to avoid damage to the unit as a result of the dirty or clogged filter.
- The area around the unit should be dry, clean and well ventilated. Clean the side heating exchanger regularly to maintain good heat exchange as conserve energy .
- The operation pressure of the refrigerant system should only be serviced by a certified technician .
- Check the power supply and cable connection often, .Should the unit begin to operate abnormally, switch it off and contact the qualified technician.
- Discharge all water in the water pump and water system ,so that freezing of the water in the pump or water system does not occur. You should discharge the water at the bottom of water pump if the unit will not be used for an extended period of time. You should check the unit thoroughly and fill the system with water fully before using it for the first time after a prolonged period of no usage.

6.APPENDIX

6. 1 Interface drawin

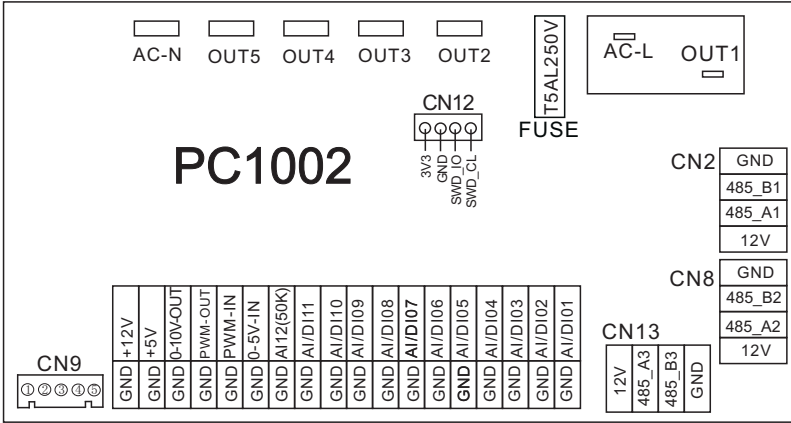

6.APPENDIX

Main board of the input and output interface instructions below

Number	Sign	Meaning
01	OUT1	Compressor(output 220-230VAC)
02	OUT2	Water pump(output 220-230VAC)
03	OUT3	4-way valve(output 220-230VAC)
04	OUT4	High speed of fan(output 220-230VAC)
05	OUT5	Low speed of fan(output 220-230VAC)
06	L	Live wire(input 220-230VAC)
07	N	Neutral wire(input 220-230VAC)
08	AI/DI01	Emergency switch(input)
09	AI/DI02	Water flow switch(input)
10	AI/DI03	System low pressure(input)
11	AI/DI04	System high pressure(input)
12	AI/DI05	System suction temperature(input)
13	AI/DI06	Water input temperature(input)
14	AI/DI07	Water output temperature(input)
15	AI/DI08	System 1 coil temperature(input)
16	AI/DI09	Ambient temperature(input)
17	AI/DI10	Mode switch(input)
18	AI/DI11	Master-slave machine switch / Antifreeze temperature (input)
19	AI/DI12(50K)	System exhaust temperature(input)
20	0_5V_IN	Compressor current detection/Pressure sensor(input)
21	PWM_IN	Master-slave machine switch / Feedback signal of EC fan(input)
22	PWM_OUT	AC fan control(output)
23	0_10V_OUT	EC fan control(output)
24	+5V	+5V(output)
25	+12V	+12V(output)
26	CN2	Frequency conversion board communications
27	CN8	WIFI / Colour line controller communication port / DC fan speed regulation module
28	CN13	Centralized control communication port
29	CN9	Electronic expansion valve

6.APPENDIX

6.2Caution & Warning

1. The unit can only be repaired by qualified installer centre personnel or an authorised dealer(for Europe market).
2. This appliance can used by children aged from 8 years and above and persons with reduced physical, sensory or mental capabilities or lack of experience and knowledge if they have been given supervision or instruction concerning use of the appliance in a safe way and understand the hazards involved(for Europe market).
Children shall not play with the appliance .Cleaning and user maintenance shall not be made by children without supervision.
3. Please make sure that the unit and power connection have good earthing, otherwise may cause electrical shock.
4. If the supply cord is damaged, it must be replaced by the manufacturer or our service agent or similarly qualified person in order to avoid a hazard.
5. Directive 2002/96/EC (WEEE):
The symbol depicting a crossed-out waste bin that is underneath the appliance indicates that this product, at the end of its useful life, must be handled separately from domestic waste, must be taken to a recycling centre for electric and electronic devices or handed back to the dealer when purchasing an equivalent appliance.
6. Directive 2002/95/EC (RoHs): This product is compliant with directive 2002/95/EC (RoHs) concerning restrictions for the use of harmful substances in electric and electronic devices.
7. The unit CANNOT be installed near the flammable gas. Once there is any leakage of the gas , fire can be occur.
8. Make sure that there is circuit breaker for the unit, lack of circuit breaker can lead to electrical shock or fire.
9. The heat pump located inside the unit is equipped with an over-load protection system. It does not allow for the unit to start for at least 3 minutes from a previous stoppage.
- 10.The unit can only be repaired by the qualified personnel of an installer center or an authorized dealer(for North America market).
11. Installation must be performed in accordance with the NEC/CEC by authorized person only (for North America market).
12. Use supply wires suitable for 75°C.
13. Caution: Single wall heat exchanger is not suitable for potable water connection.

6.APPENDIX

6.3 Cable specification

1. Single phase unit

Nameplate maximum current	Phase line	Earth line	MCB	Creepage protector	Signal line
No more than 10A	2×1.5mm ²	1.5mm ²	20A	30mA less than 0.1 sec	n×0.5mm ²
10~16A	2×2.5mm ²	2.5mm ²	32A	30mA less than 0.1 sec	
16~25A	2×4mm ²	4mm ²	40A	30mA less than 0.1 sec	
25~32A	2×6mm ²	6mm ²	40A	30mA less than 0.1 sec	
32~40A	2×10mm ²	10mm ²	63A	30mA less than 0.1 sec	
40~63A	2×16mm ²	16mm ²	80A	30mA less than 0.1 sec	
63~75A	2×25mm ²	25mm ²	100A	30mA less than 0.1 sec	
75~101A	2×25mm ²	25mm ²	125A	30mA less than 0.1 sec	
101~123A	2×35mm ²	35mm ²	160A	30mA less than 0.1 sec	
123~148A	2×50mm ²	50mm ²	225A	30mA less than 0.1 sec	
148~186A	2×70mm ²	70mm ²	250A	30mA less than 0.1 sec	
186~224A	2×95mm ²	95mm ²	280A	30mA less than 0.1 sec	

2. Three phase unit

Nameplate maximum current	Phase line	Earth line	MCB	Creepage protector	Signal line
No more than 10A	3×1.5mm ²	1.5mm ²	20A	30mA less than 0.1 sec	n×0.5mm ²
10~16A	3×2.5mm ²	2.5mm ²	32A	30mA less than 0.1 sec	
16~25A	3×4mm ²	4mm ²	40A	30mA less than 0.1 sec	
25~32A	3×6mm ²	6mm ²	40A	30mA less than 0.1 sec	
32~40A	3×10mm ²	10mm ²	63A	30mA less than 0.1 sec	
40~63A	3×16mm ²	16mm ²	80A	30mA less than 0.1 sec	
63~75A	3×25mm ²	25mm ²	100A	30mA less than 0.1 sec	
75~101A	3×25mm ²	25mm ²	125A	30mA less than 0.1 sec	
101~123A	3×35mm ²	35mm ²	160A	30mA less than 0.1 sec	
123~148A	3×50mm ²	50mm ²	225A	30mA less than 0.1 sec	
148~186A	3×70mm ²	70mm ²	250A	30mA less than 0.1 sec	
186~224A	3×95mm ²	95mm ²	280A	30mA less than 0.1 sec	

When the unit will be installed at outdoor, please use the cable which can against UV.

Note: _____
